

Operation manual



ZGR EFFICIENT RT 6 - 10 KVA

Online Single-phase UPS

INDEX

1	PRECAUTIONS	3
1.1	General precautions	3
1.2	Storage precautions	4
1.3	Environmental precautions	5
1.4	Precautions on the transportation of the unit	5
1.5	Precautions on receiving the unit	6
1.6	Symbol Description	6
2	GENERAL DESCRIPTION	7
2.1	Introduction	7
2.2	Operation principle	7
2.3	Main characteristics	8
2.4	Construction of ZGR EFFICIENT RT 6 - 10 KVA	8
3	INSTALLATION	9
3.1	Receiving the material	9
3.2	Installation conditions	10
3.3	Mechanical installation	11
3.4	Electrical installation	11
	3.4.1 External Protective Devices	11
	3.4.2 UPS input and output connection	13
	3.4.3 External battery connection (for extend model only - LBT)	13
4	OPERATION OF ZGR EFFICIENT RT 6 - 10 KVA	14
4.1	Operation Modes	14
	4.1.1 Normal mode	15
	4.1.2 Battery mode (Stored Energy Mode)	15
	4.1.3 Bypass mode	15
	4.1.4 ECO Mode	15
	4.1.5 Parallel redundancy mode (system expansion)	15
	4.1.6 Parallel function setup	15
	4.1.7 Parallel cable installation	16
	4.1.8 Bypass mode in parallel working mode	17
4.2	Initial start-up	18
	4.2.1 Power-up with mains utility	18
	4.2.2 Black (Cold) start procedure	18
	4.2.3 Inverter Off	19
	4.2.4 Disconnecting with Utility	19
4.3	LCD control panel	20
	4.3.1 Display information	20
	4.3.2 Available interfaces in the LCD display	21
4.4	Parameters setting	22
	4.4.1 Operation Mode setting (mod)	23
	4.4.2 Operation Output voltage setting (OPV)	23
	4.4.3 Operation Output frequency setting (OPF)	24
	4.4.4 Battery capacity setting (bAH)	24

4.4.5	Battery number/quantity setting (bN).....	24
4.4.6	Bypass High Level switch setting (HLS)	25
4.4.7	Bypass Low Level switch setting (LLS).....	25
4.4.8	Buzzer Mute Setting (bZ)	26
4.4.9	Battery Test Setting (tSt).....	26
4.4.10	Parallel ID setting (PId)	27
4.4.11	Parallel quantity setting (PN)	28
4.4.12	Parallel redundancy quantity setting (PrN).....	28
4.5	List of events and status	29
5	COMMUNICATIONS.....	31
5.1	Communications	31
5.1.1	Connection of the UPS communication cables	31
5.2	Intelligent slot	31
5.2.1	TCP-IP communications card (optional)	32
5.2.2	Dry-contact relay card (optional).....	33
5.3	UPS remote access	34
5.3.1	IP manual assignment.....	34
5.3.2	NetAgent webserver main screen	34
6	TROUBLESHOOTING.....	36
6.1	Malfunctions of ZGR EFFICIENT RT 6 - 10 KVA	36
7	MAINTENANCE	37
7.1	Battery maintenance	38
8	TECHNICAL SPECIFICATIONS	39
9	STANDARDS.....	41
10	WARRANTY.....	42

© 2024, ZIGOR

All rights reserved. The total or partial reproduction of this User Manual, or its transmission of any type or by any means, be this mechanical or electronic, by means of photocopies, registration or other information storage or recovery procedure, without the permission of the editor, is totally forbidden.

The contents of this manual are exact at the time it was printed. However, with the intention of complying with our aim of continuous development and improvement, the manufacturer reserves the right to change the specifications of the product, its operation or the contents of the Operating Manual without prior warning.

1 PRECAUTIONS

1.1 General precautions

For your own safety and that of the unit, you must read and understand the instructions contained in this document before starting work.

Keep these instructions in a place accessible to all the personnel who work with the unit so that they can be consulted.

Only expert and duly authorised personnel may operate our units.



Danger warnings. When handling or accessing the interior of the ZGR EFFICIENT RT 6 - 10 KVA, please remember that some parts may be live. Pay special attention to soldering points, printed circuits, connecting terminals, relay contacts, etc. Before opening the equipment, disconnect the voltage of all poles (both alternating and direct) and wait at least 5 minutes for the internal condensers to discharge.

Arbitrary modifications are forbidden. The unit must not be subjected to any modification regarding its construction or safety without ZIGOR's express consent. Any modification will free ZIGOR of any responsibility for any damage caused as a result of the modification. In particular, all repair work, soldering of printed circuit boards and replacing of components, modules and printed circuit boards, without the express authorisation of ZIGOR, is forbidden. Should spare parts be used, only ZIGOR original parts shall be utilised.

Use the unit for the purpose for which it was designed. The system supplied must be used only for the purpose for which it was designed. Any other use is strictly forbidden. ZIGOR cannot accept responsibility for any damage that might result from its use for any other purpose. In such cases, the user shall assume exclusive responsibility for any risk. The use for which the unit was designed is defined in the documentation. The system shall be exposed only to admissible environmental conditions. These are defined in the technical details provided for the equipment.

ZIGOR accepts no responsibility for any inadequate, negligent or incorrect installation of the equipment.



This supply equipment contains a lethal voltage. Comply with the instructions set out in this manual to avoid any risk of electrical shock.

Please follow the indications set out below to operate under conditions of complete safety:

- The System must be checked once the installation has been completed by a qualified technician and before being put into operation. Should these indications not be adhered to, the warranty shall be considered null and void.
- These units do not contain parts usable for other purposes by the user.
- Do not power up the device before a technician has checked it.
- Given the risk of electric shock or burns, do not try to open the device.
- Work inside the cabinet should be undertaken only by qualified personnel who are familiar with the safety measures to be applied and the specific technical characteristics of the unit.
- The unit does not contain any user repairable or replaceable elements. In the case of any malfunction or problems operating the unit, please contact ZIGOR.
- Do not place the system near power magnets as this might cause a malfunction.
- Do not block or cover the ventilation grills in the housing.
- The ZGR EFFICIENT RT 6 - 10 KVA is designed in accordance with current Spanish legislation. Check these regulations against those corresponding to the country in which the unit is to be installed and against the most restrictive regulations of the electricity supplier.
- All user controls are accessible from the exterior.
- This system has been designed for industrial use and not for domestic-commercial use.

- they are not live.
- This system has been designed for industrial use and not for domestic-commercial use.
- If any liquid is spilled accidentally on the System, disconnect this and consult ZIGOR personnel.
- During assembly work, start-up or maintenance, wear goggles to avoid any damage to your eyes due to accidental electric arcing.
- Use only insulated tools.
- The unit must be protected against rain and excess humidity and installed in a clean atmosphere, without inflammable liquids, gases or oxidising substances.
- The battery may pose a risk of electric shock or burns due to its high short circuit current.
- If the batteries lose electrolyte or are physically damaged, they must be placed in a container in resistant to corrosive liquids (acids or alkaline according to the type of battery) and prepared in accordance with local regulations.
- If the electrolyte comes into contact with the skin, the affected area must be washed immediately with clean water.
- Only authorized personnel should repair or install the batteries.
- Should you have any problems with the contents of this manual, you must ask ZIGOR for assistance.

1.2 Storage precautions

The store where the material is kept must protect the material from the elements, risk of flooding or contact with water.

The material shall be protected from any risk of overheating due to exposure to direct sunlight or through windows.

The recommended storage temperature is from 15°C to 25°C. An increase of 10°C can reduce the service life of the battery by 50%. The recommended relative humidity is from 30% to 90%.

To avoid any risk of mechanical shock, do not stack the packages. These must be placed in accordance with the silkscreen printed details on the boxes used for packaging.

Before storing, charge the UPS 5 hours. Store the UPS covered and upright in a cool, dry location. During storage, recharge the battery in accordance with the Table 1-1:

STORAGE TEMPERATURE	RECHARGE FREQUENCY	CHARGING DURATION
-25°C - 40°C	Every 3 months	1-2 hours
40°C - 45°C	Every 2 months	1-2 hours

Table 1-1 Storage temperatures



WARNING

Any failure to respect these precautions may render the product warranty null and void.

1.3 Environmental precautions



Dispose of the packaging in an ecological way: ZIGOR, based on the exceptions detailed in the First Additional Provision of Law 11/1997 on commercial or industrial packaging, informs that the final holder of the waste of used containers and packaging, as responsible for them, you must deliver them in appropriate conditions for reuse, to an authorized recuperator, recycler or re-valuer.

The subsets of the system are recyclable products and cannot be treated as household / municipal waste at the end of its useful life.

To preserve the environment, manage them in accordance with current environmental regulations and requirements in each country or community. In case of doubt, consult the manufacturer.



Correct product disposal: This electrical-electronic device (AEE) is marked with the symbol of compliance with the European Directive 2012/19 / EU (WEEE) regarding used electrical and electronic equipment (Waste electrical and electronic equipment WEEE, RD 110/2015).

The Directive provides the general framework valid throughout the European Union for the removal and reuse of waste from EEE.

To dispose of this product and ensure its proper management, follow the current local environmental legislation and regulations. In this way it will contribute to conserve the

Correct disposal of batteries: Used batteries are reusable consumer products and a recycling process must be carried out.

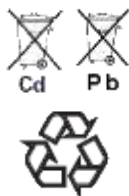

Used batteries that do not go through the recycling process must be disposed of according to the instructions regarding special waste, in accordance with the regulations and environmental requirements in force in each country or community. This requirement applies in the European Union and in those places where separate collection systems are available.

In case of doubt, consult the manufacturer.

In this way it will contribute to conserve the environment.

1.4 Precautions on the transportation of the unit

Please transport the UPS system only in the original package to protect against shock and impact. The procedure to transport of the UPS to the final location should follow the procedure:

1. Use a pallet truck to transport the UPS to the installation position.
2. Check the UPS packing.
3. **Don't lean the UPS when moving it out from the packaging.**
4. Check the appearance to see if the UPS is damaged or not during the transportation, do not switch on the UPS if any damage found. Please contact the dealer right away.
5. Check the accessories according to the packing list and contact the dealer in case of missing parts.

1.5 Precautions on receiving the unit

Visually check that the UPS location is adequate by checking its characteristics (clean, free of leaks with good ventilation); the floor must be level and have sufficient load resistance for the equipment.

Checking the material

- On receiving the material, a visual inspection should be made in order to detect any anomalies that may have occurred during transport.
- List and check all the items indicated on the delivery note. Should any component be missing, notify the forwarding agent within the established deadline.
- Extract all parts from the packaging and examine the unit for any damage caused during transport.
- Report any damage to the forwarding agent and ZIGOR.
- Check that the material delivered corresponds to the delivery note. Check the manufacturer's label placed at the rear or on one side of the unit.
- Responsibility for the loss or damage of Products shall transfer to the Customer from the moment ZIGOR, places these at his disposal in the place indicated by the Customer.

From then on, the customer will have 24 hours to make any claim under guarantee for any anomaly in the amount or quality of the products received, providing details of the material received in bad condition after reporting this circumstance on the forwarding agent's delivery note on reception.

Should the customer not report any defect within 24 hours, it will be understood that he has accepted delivery of the unit.

1.6 Symbol Description

The safety symbols cited in this manual are shown in Table 1-1, which are used to inform readers of safety issues that should be obeyed when installation, operation and maintenance.



SECURITY SYMBOL	INDICATION
	Attention
	Static discharge sensitive
	Risk of electric shock

Table 1-1 Security symbols meaning





SYMBOL	INDICATION
	Turn ON/OFF the UPS
	Alternating current source (AC)
	Direct current source (DC)
	Protective ground

Table 1-2 Symbol meaning

2 GENERAL DESCRIPTION

2.1 Introduction

ZGR EFFICIENT RT 6 - 10 KVA is an intelligent, Single phase in -> Single phase out, high frequency online UPS. With excellent electrical performance, perfect intelligent monitoring and network functions, smart appearance, complying with EMC and safety standards. **This UPS has become standard product which meets the world's advanced level.**

ZGR EFFICIENT RT 6 - 10 KVA goes one step further, and seeks to meet the needs of customers with greater demand for protected power in 6 and 10 kVA versions, providing the best power solution for vital applications and critical devices that require maximum reliability and efficiency thanks to its Power Factor and efficiency of up to 94%.

This range of UPS is modularized and adopts the N+X redundancy. It can flexibly increase the number of the UPS modules according to the load capacity which is convenient for flexible allocation and gradually investment.

The UPS can solve most of the power supply problems, such as blackout, over-voltage, under-voltage, voltage sudden drop, oscillating of decreasing extent, high voltage pulse, voltage fluctuation, surge, inrush current, harmonic distortion (THD), noise interference, frequency fluctuation, etc..

This UPS can be applied to different applications from computer device, automatic equipment, communication system to industry equipment.

It is perfect for protecting industrial applications, servers, banks, IT equipment and networks.

It is possible to extend autonomy several hours using external batteries (LBT versions) with reinforced battery charger.

POWER	NUMBER OF BATTERIES
6 kVA	16~20 external batteries (12 V/ud)
10 kVA	16~20 external batteries (12 V/ud)

Table 2-1 ZGR EFFICIENT RT 6 - 10 KVA range

2.2 Operation principle

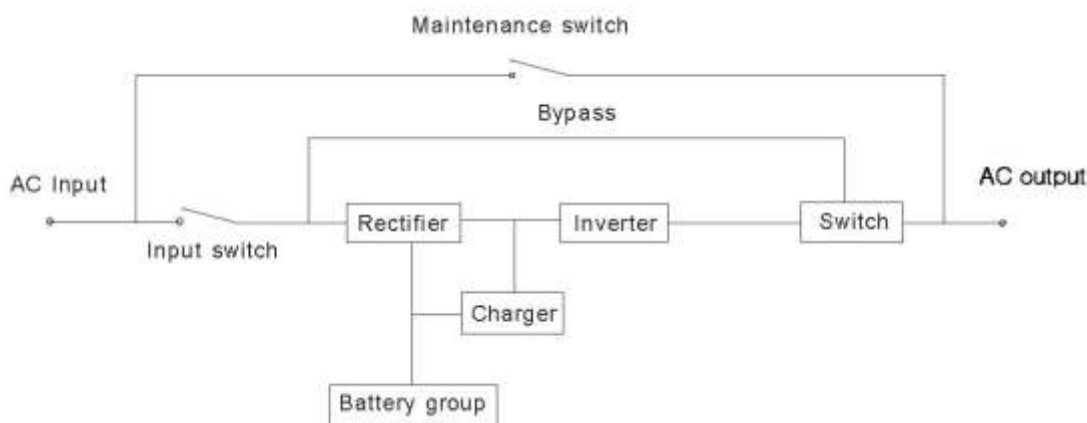

Fig. 2-1 ZGR EFFICIENT RT 6 - 10 KVA block diagram

ZGR EFFICIENT RT 6 – 10 KVA combines the following components:

- Input filter: Complete filtering the input AC utility power to provide the clean power for UPS.
- AC/DC converter: Convert the filtered AC mains to DC power for the inverter and battery charger.
- DC/DC booster: When the UPS works in battery mode, the circuit boosts the DC for DC/AC inverter.
- DC/AC inverter: Convert the boosted DC power to stable AC output.
- Bypass: When overload or UPS failure, it transfers to bypass mode to supply power to loads directly from mains through and electronic switch.

- Charger: Charge battery with intelligent power controller. Standard unit provides 1A; Long Backup unit (LBT) provides up to 10A Max (settable).
- Battery: Our recommendation is for Sealed Lead Acid Battery.
- Output filter: Output filtering board to provide the clean power to loads.

2.3 Main characteristics

- Power Factor of 1,0
- Parallelable up to 4 units
- Can be configured as common battery
- Long autonomy models available
- Pure sinewave output
- SNMP communications card and dry contacts
- 3-level smart charger
- Frequency converter function 50 <-> 60 Hz
- LCD display
- ECO function with performance > 96%
- Cold Start and Auto Restart function
- Self-battery and UPS diagnosis
- Double conversion online (Rectifier / Inverter): It completely isolates consumer loads from mains voltage and frequency variations and noise.
- Management and monitoring: Via software, USB / RS232 connection
- EPO (Emergency Power OFF) function: Terminal on rear panel and/or front panel button

2.4 Construction of ZGR EFFICIENT RT 6 - 10 KVA

Below front and rear views of ZGR EFFICIENT RT 6 - 10 KVA(Fig. 2-2, Fig. 2-3 y Fig. 2-4):

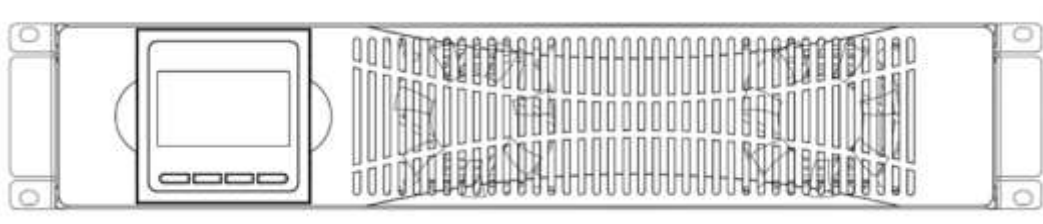

Fig. 2-2 Front view

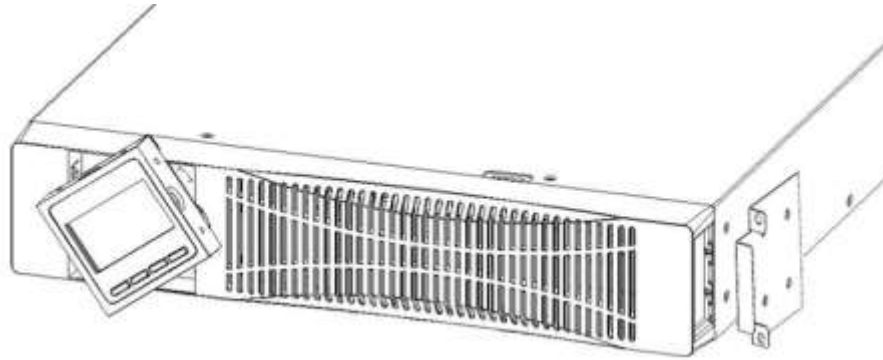

Fig. 2-3 3D view

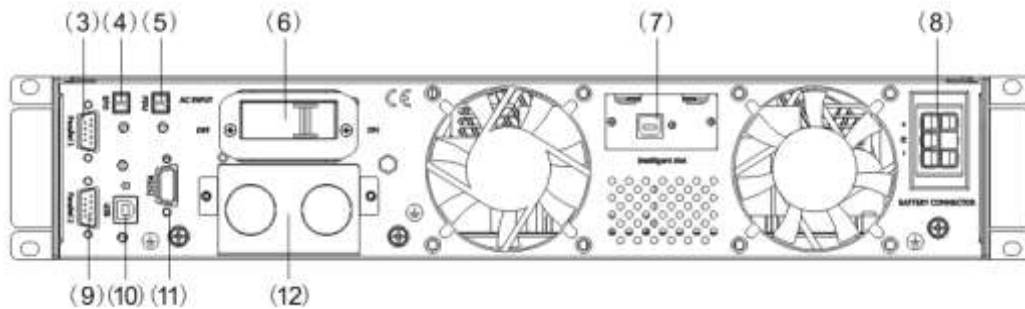

Fig. 2-4 Rear view

The available elements and connectors in the front and rear panel are (Fig. 2-4):

Handles	(7) Intelligent slot
LCD Display	(8) Battery connector
(3) Parallel Port 1	(9) Parallel Port 2
(4) PDU port	(10) USB comm port
(5) EPO port	(11) COM (RS232)
(6) Input Breaker	(12) Input/Output terminals

3 INSTALLATION

3.1 Receiving the material

Don't lean the UPS when moving it out from the packaging.

Check the appearance to see if the UPS is damaged during transportation, do not switch on the UPS if any damaged is found and please contact the dealer.

Check the accessories according to the packing list and contact the dealer if any parts missing.

No claims will be accepted if, 24 hours following the delivery of the goods, no notification of reception of material in bad conditions has been received and if this circumstance is not notified to the forwarding agent on the corresponding delivery note at the time of delivery.



WARNING

Ensure that the weight of the unit is within the maximum load limits (kg) of the tools used in order to handle it and the supports used to secure it in place. Review weight details in the specifications of the ZGR EFFICIENT R 6 – 10 KVA.

3.2 Installation conditions

- Please place the UPS in a clean, stable environment, avoid the vibration, dust, humidity, flammable gas and liquid, corrosive objects. To avoid from high room temperature, a system of room extractor fans is recommended to be installed. Optional air filters are available if the UPS operates in a dusty environment.
- The environment temperature around the UPS should keep in a range of 0°C~40°C. If the environment temperature exceeds 40°C, the rated load capacity should be reduced by 12% per 5°C. The max temperature can't be higher than 50°C.
- If the UPS is dismantled under low temperature, it might be in a condensing condition. The UPS can't be installed unless the internal and external of the equipment is fully dry. Otherwise, there will be in danger of electric shock.
- Batteries should be mounted in an environment where the temperature is within the required specs. Temperature is a major factor in determining battery life and capacity. In a normal installation, the battery temperature is maintained between 15°C and 25°C. Keep batteries away from heat sources or main air ventilation area, etc.



WARNING

Typical battery performance data are quoted for an operating temperature between 20°C and 25°C. Operating it above this range will reduce the battery life while operation below this range will reduce the battery capacity.

- Should the equipment not be installed immediately it must be stored in a room so as to protect it against excessive humidity and or heat sources.



WARNING

An unused battery must be recharged every 3months. Temporarily connecting the UPS to a suitable AC supply and activating it for the time required for recharging the batteries are required.

- The highest altitude that UPS may work normally with full load is 1500 meters. The load capacity should be reduced when this UPS is installed in place whose altitude is higher than 1500 meters, shown as the Table 3-1:

(Load coefficient equals max load in high altitude place divided by nominal power of the UPS)

ALTITUDE (m)	1500	2000	2500	3000	3500	4000	4500	5000
LOAD COEFFICIENT	100%	95 %	90 %	85 %	80 %	75 %	70 %	65 %

Table 3-1 Load coefficient

3.3 Mechanical installation

- Install UPS on a rack mount cabinet over flat and stable surface.
- **Keep UPS at least 20 cm from wall or equipment or other object. Don't block the ventilation holes of the UPS front panel and bottom part, so as to keep the ventilation in good conditions, avoid temperature of components inside getting high.**
- Keep the UPS away from high temperature, water, flammable gas, corrosive gas, dust, direct sunlight; **explosive things don't lay the UPS outdoor**
- Install a double-pole joined MCB switch with more than 40 A/63 A (6 kVA/10 kVA) at the input and output L-N, in order to cut off the power when in emergency situation.
- Different kind of loads like computer, linear load and small inductive load can be connected to the UPS. Please contact ZIGOR if other types of loads are required to connect.
- For user and equipments security reasons, please be sure to take correct power configuration.

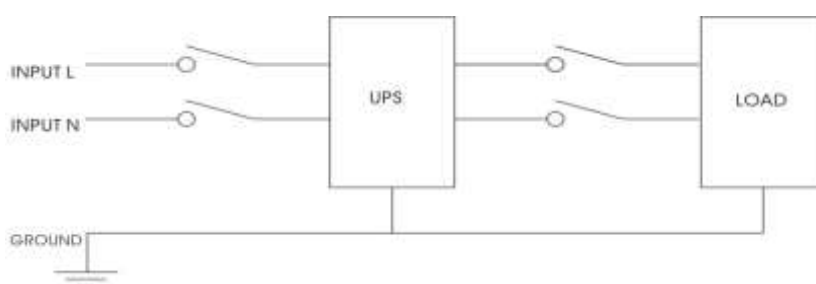

Fig. 3-1 Correct power configuration

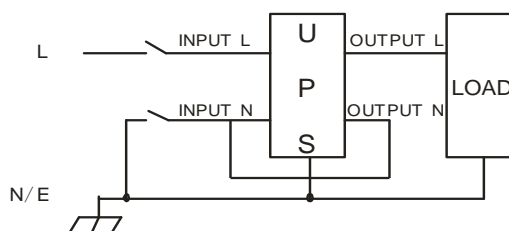

Fig. 3-2 Wrong power configuration

3.4 Electrical installation

3.4.1 External Protective Devices

For safety reasons, it is necessary to install, external circuit breaker at the input A.C. supply and the battery. This chapter provides guidelines for qualified installers that must have the knowledge of local wiring practices for the equipment to be installed.

- External Battery

The UPS and its associated batteries are protected against the effect of over-current through a DC compatible thermo-magnetic circuit-breaker (or a set of fuses) located close to the battery.

- UPS Output

Any external distribution board used for load distribution shall be fitted with protective devices that may avoid the risk of UPS overloaded.

- Over-current

Protection device shall be installed at the distribution panel of the incoming main supply. It may identify the power cables current capacity as well as the overload capacity of the system.

**WARNING**

Select a thermomagnetic circuit-breaker with an IEC 60947-2 trip curve C (normal) for 125% of the current as listed below

All electrical connections of the UPS are made from the rear side of the device.

Take the following steps into consideration in order to make the connections of the equipment:

1. Before any manipulation, make sure wires are not energized.
2. Remove the small cover of the output terminals and connect the wires.
3. Connect the input cable to correct terminals on the rear of the equipment.
4. Connect the loads to defined terminals.
5. Connect battery cabinet wires to defined terminals BAT+ / BAT-N / BAT-
 - o Pay attention to verify that battery cabinet breaker is open/OFF
6. Double check correct wiring and polarities wires are securely affixed.
7. Put the small cover back to the rear panel.

**WARNING**

Battery type, aging or manufacturer should not be mixed. If you want to increase UPS autonomy or replace batteries, contact ZIGOR customer service and follow our recommendations.

**WARNING**

Batteries must be installed exclusively by personnel authorised by ZIGOR. ZIGOR takes no responsibility for damage caused by external batteries installed by personnel not authorised by ZIGOR.

Follow these steps with care:

- *The voltage of battery terminals is dangerous even when the UPS is not in operation. Access to the interior of the battery cabinet shall be restricted to trained personnel.*
- *A short-circuit on the battery terminals (or of one of its elements) before the breaker or fuse is EXTREMELY DANGEROUS as the current will be limited only by the internal resistance of the battery and the wiring. These extremely high currents can cause the battery to explode, melt cables, tools and other metal objects.*
- *Do not attempt to open the batteries. These contain electrolyte, which can cause burns to eyes and skin.*
- *Do not wear rings, bracelets, watches, etc., as these could cause short-circuits or electric shocks.*
- *Use insulated tools.*
- *Wear gloves, insulated protective shoe wear and safety goggles.*
- *Discharge body static electricity before making connections.*
- *Do not place tools on the batteries.*
- *Do not place batteries near fire or high heat emitters.*

In case of doubt, contact our customer service (sac@zigor.com).

3.4.2 UPS input and output connection

Minimum 10 AWG / 6 mm² copper wires are required for the 6 kVA, and 8 AWG / 10 mm² for 10kVA, including input/output cables, battery cables.

- 1) Switch off all breakers before connecting cables
- 2) Remove terminals cover, see Fig. 3-3, following it to connect the cables
- 3) Connect the UPS output L, N, GND to load L, N, GND via a Power Distribution Unit (PDU) or MCB switches. Tighten the screws and shelter the terminals



WARNING!

Terminators are required to ensure the connections are firm.

Don't reverse the input L and N.

Don't connect the UPS input to a wall outlet or the outlet will get burnt.

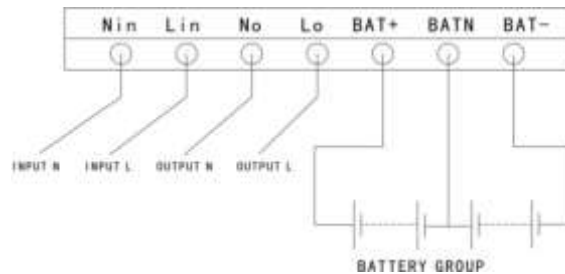

Fig. 3-3 I/O terminals connection

3.4.3 External battery connection (for extend model only - LBT)

- 1) Make sure battery quantity complies with the specs (16 / 18 / 20 pieces of 12V battery). Measure the voltage of battery bank after finishing connection and the battery voltage should be around 192 / 216 / 240 Vdc \pm 2,3 V x N battery pieces.
- 2) The breaker on battery cabinet should be off.
- 3) **Remove terminals' cover, use multimeter to make sure there is no DC voltage at the battery terminals of UPS (Fig. 3-4).**
- 4) Connect battery with positive pole, negative pole and middle point common pole to battery connector (BAT+, BATN, BAT-) , **don't reverse battery connection.**

All 3 wires from battery to UPS must be same section.

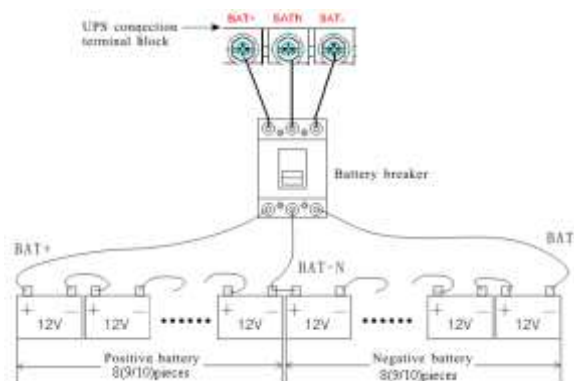

Fig. 3-4 External battery connection

All UPS will be set in factory based on customer needs. All related settings can be modified by LCD display menu.

All this adjustments must be done by trained and authorized personal, or contact ZIGOR to receive training or technical assistance.

**WARNING**

Before installing battery, make sure that the UPS and breaker are all turned off. Remove all your metallic adornment such as finger ring, watch, and so on before connecting battery.

Do not cross connect or short circuit battery poles. Red cable connect to battery positive “+” and black cable connect to negative “-”.

Please use the screwdriver with insulating handle. Do not lay the tools or metallic goods on the battery.

**PRECAUTION**

When using the external battery it is best to use battery cable which matches UPS maximum power.

When connecting load to UPS, first turn off load and then connect the power cable and finally turn on load one-by-one.

Inductance loads such as motor, fluorescent lamp, and photocopier are strictly prohibited connecting to UPS to avoid damage.

Plug UPS on the special socket with over-current protection, for safety reasons the power socket used should be connected with ground wire.

UPS is likely to have output voltage no matter whether the power input cable is plugged in mains input socket. If you wish UPS have no output, first break off the switch and then cancel the mains.

When connect laser printer, select the capacity of UPS according to the printer start power because the startup power is higher.

4 OPERATION OF ZGR EFFICIENT RT 6 - 10 KVA

The operation is simple; the user only needs to read the manual and follow the operation instructions listed in this manual no need any special training.

**WARNING**

Verify that total power from loads do not exceed maximum selected UPS power to prevent overload alarms.

4.1 Operation Modes

The ZGR EFFICIENT RT 6 - 10 KVA is a double-conversion on-line UPS that can operate in the following alternative modes:

4.1.1 Normal mode

The rectifier/charger derives power from the AC mains and supplies DC power to the inverter while floating and boosting charge the battery simultaneously. Then, the inverter converts the DC power to AC and supplies to the load.

4.1.2 Battery mode (Stored Energy Mode)

If the AC mains input power fails, the inverter, which obtains power from the battery, supplies the critical AC load. There is no power interruption to the critical load. The UPS will automatically return to Normal Mode when AC supply recovers.

4.1.3 Bypass mode

If the inverter is out of order, or if overload occurs, the static transfer switch will be activated to transfer the load from the inverter supply to bypass supply without interruption to the critical load.

In the event that the inverter output is not synchronized with the bypass AC source, the static switch will perform a transfer of the load from the inverter to the bypass with power interruption to the critical AC load. This is to avoid paralleling of unsynchronized AC sources. This interruption is programmable but typically set to be less than an electrical cycle e.g. less than 15 ms (50 Hz) or less than 13,33 ms (60 Hz).

4.1.4 ECO Mode

When the UPS is at AC Mode and the requirement to the load is not critical, the UPS can be set at ECO mode in order to increase the efficiency of the power supplied. At ECO mode, the UPS works at Line-interactive mode, so the UPS will transfer to bypass supply.

When the AC is out of set window, the UPS will transfer from bypass to Inverter and supplies power from the battery, and the LCD will show all related information on the screen.

4.1.5 Parallel redundancy mode (system expansion)

To achieve a higher capacity and / or increase reliability, the outputs of up to 4 UPS modules can be programmed to operate in parallel. The built-in parallel controller in each UPS ensures automatic load sharing.

In case of one module fail, the other modules assume the power and loads could be run protected.

This is a great advantage compared to single UPS system, because in case of single UPS failure whole system goes to bypass mode, and loads will not be protected from mains variations.

Please, check how much power needs to assumed by whole running parallel system in order to determine maximum UPS quantity, and prevent to overload situation in case of module failure.

4.1.6 Parallel function setup

A group of paralleled modules behave as one large UPS system but with the advantage of presenting higher reliability. In order to assure that all modules are equally utilized and comply with relevant wiring rules, please follow the requirements below:

- 1) All UPS must be of the same rating and be connected to the same bypass source.
- 2) The Bypass and the Main input sources must be referenced to the same neutral potential.
- 3) The outputs of all the UPS modules must be connected to a common output bus.
- 4) It is recommended that the length and specification of power cables including the bypass input cables and the UPS output cables should be the same. This facilitates load sharing when operating in bypass mode.

The basic installation procedure of a parallel system comprising of two or more UPS modules is the same as that of single module system. The following sections introduce the installation procedures specified to the parallel system.

Parallel installation steps as below:

- 1) Connect the UPS with parallel cables.

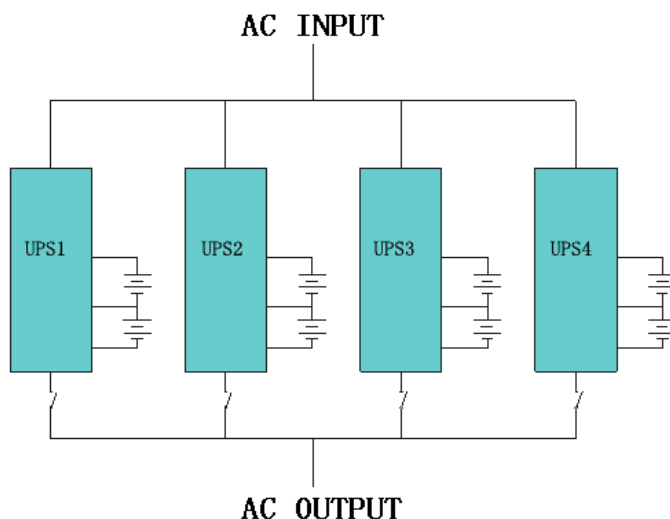

Fig. 4-1 Parallel connection

- 2) Connect all the outputs of the parallel UPS using individual breakers to one patch board before connect to the loads. See the Fig. 4-1 as follows.
- 3) Adjust each UPS settings through LCD. See the Manual Chapter 4.3.1; 4.3.10; 4.3.11; 4.3.12.
 - A. Each UPS must be configured individually.
 - B. Set relevant parameters as below :
 - ① Working mode: set as Parallel operation (PAL);
 - ② Parallel ID: set different UPS ID one by one;
 - ③ Parallel amount: set the amount of UPS in parallel.
 - C. Power OFF UPS and continue with next unit.
- 4) Now close output breakers to make work in parallel mode
- 5) Once all UPS was configured, make sure all connections and wire sequence are correct, and then can be powered ON at same time or one by one.



When the UPS in parallel, the input can be the same or different, but the output should be paralleled to one patch board.



WARNING!

Make sure the N, L lines are correct, and ground is well connected.

4.1.7 Parallel cable installation

Shielded and double insulated control cables available must be interconnected in a ring configuration between UPS modules as shown (Fig. 4-2). The parallel control board is included on each UPS module. The ring configuration ensures high reliability of the control.

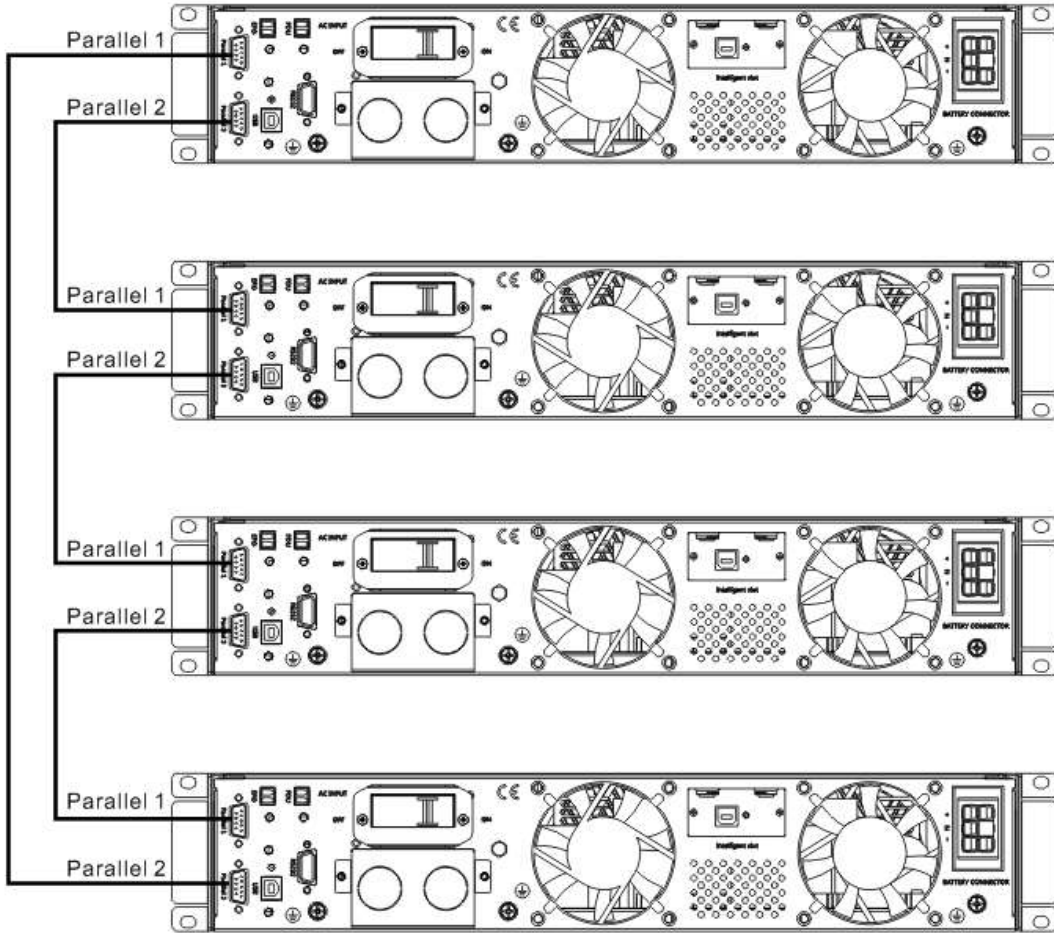
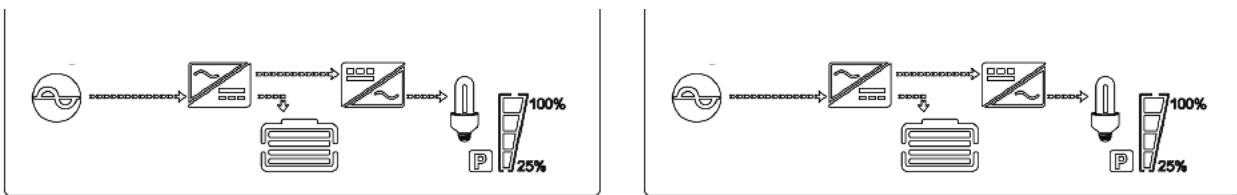

Fig. 4-2 Parallel cable installation

4.1.8 Bypass mode in parallel working mode

Under normal Online working mode for all parallel UPS, following information could be show on LCD display. Two UPS in parallel mode..



Two UPS working normally in parallel Online mode

ESC/OFF button must be push on each UPS to stop inverter mode.

- ① Each UPS will stop and disconnect inverter circuit;
- ② Rest of UPS will asume total load;

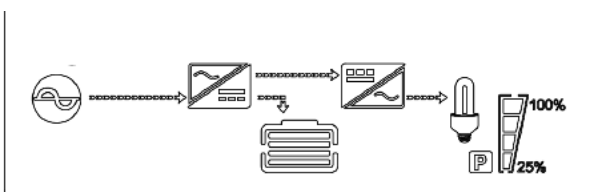

UPS 1 in Online mode

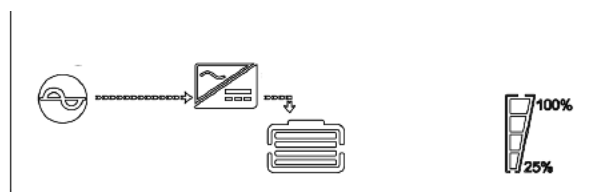

UPS 2 inverter stopped

The last UPS to be stopped will force whole system to transfer to bypass mode simultaneously

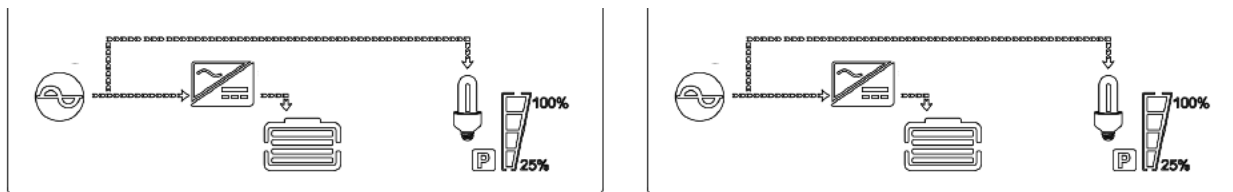

Two UPS transferred to bypass mode

To return to normal inverter mode, reverse procedure must be done pushing ENTER/ON on each UPS

NOTE: Pay attention because full load power could be assumed by only one UPS, and in this situation overload alarm will appear.

4.2 Initial start-up

4.2.1 Power-up with mains utility

Do not disconnect the mains cable on the UPS system or the building wiring outlet (shockproof socket outlet) during operations since this would cancel the protective earthing of the UPS system and of all connected loads.

The UPS system features its own, internal current source (batteries). The UPS output sockets or output terminals block may be electrically live even if the UPS system is not connected to the building wiring outlet.



PRECAUTION

Make sure grounding is properly done.

- Set the Battery Breaker to the “ON” position according to the user’s manual.
- Switch on the UPS



PRECAUTION

Check to see if the load is safely connected with the output of the UPS. If the load is not ready to receive power from the UPS, make sure that it is safely isolated from the UPS output terminals

The internal fan of the UPS starts spinning, the UPS is performing self-diagnostics until buzzer beeps twice to show the UPS is normal. Then, the UPS goes to bypass supply, Utility LED and Bypass LED turn green, the inverter is starting up now. **When the inverter is checked “normal”, the UPS goes to working mode and the load is supplied by the inverter now.**

No matter the UPS is operated normally or not, the LCD display will indicate current status. The top lines display the UPS operational status and the bottom lines indicate alarm conditions when they occur.

4.2.2 Black (Cold) start procedure

Follow these procedures when the input AC Utility Failure, but battery is normal

- Turn on the battery switch. The battery will feed the Auxiliary power board.
- Trigger the cold start buttons at the position 9 in Fig. 4-3.

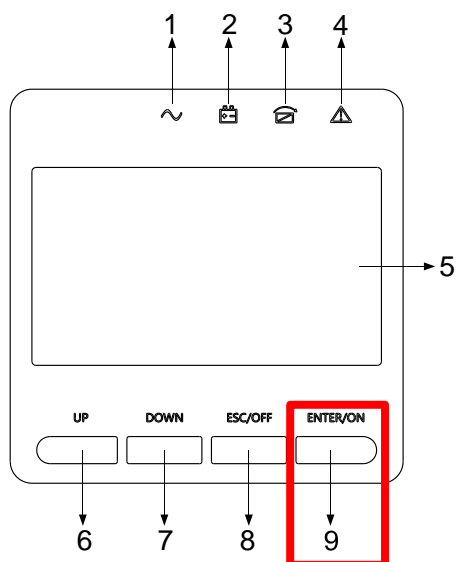

Fig. 4-3 Cold Start button

When battery normal, rectifier starts operation, 30 s later, inverter starts and operates, INV and output light up.



PRECAUTION

Wait for approximately 30 seconds before you press the black start key.

4.2.3 Inverter Off

When the Utility is normal, press “ESC /OFF” button for approx. 1 sec until beep sounds, the inverter LED will extinguish, the bypass LED on, then the UPS turns to bypass supply.

When the UPS is on battery mode or without AC, press “ESC /OFF” button for approx. 1 sec until beep sounds, the output of the UPS is off, fan stop spinning. After 60 seconds, all the LED on the LCD display extinguish.

4.2.4 Disconnecting with Utility



PRECAUTION

This procedure should be followed to completely shut down the UPS and the LOAD. After all power switches, isolators and circuit breakers are opened, there will be no output.

After the inverter is off, turn the Utility and battery breakers to “OFF”, then the LCD display will extinguish completely and fan stops spinning in 60 seconds. If there are external battery packs connected, please also turn the battery breaker to “OFF”.



PRECAUTION

Wait for about 5 minutes for the internal D.C. bus bar capacitors to be completely discharged.

4.3 LCD control panel

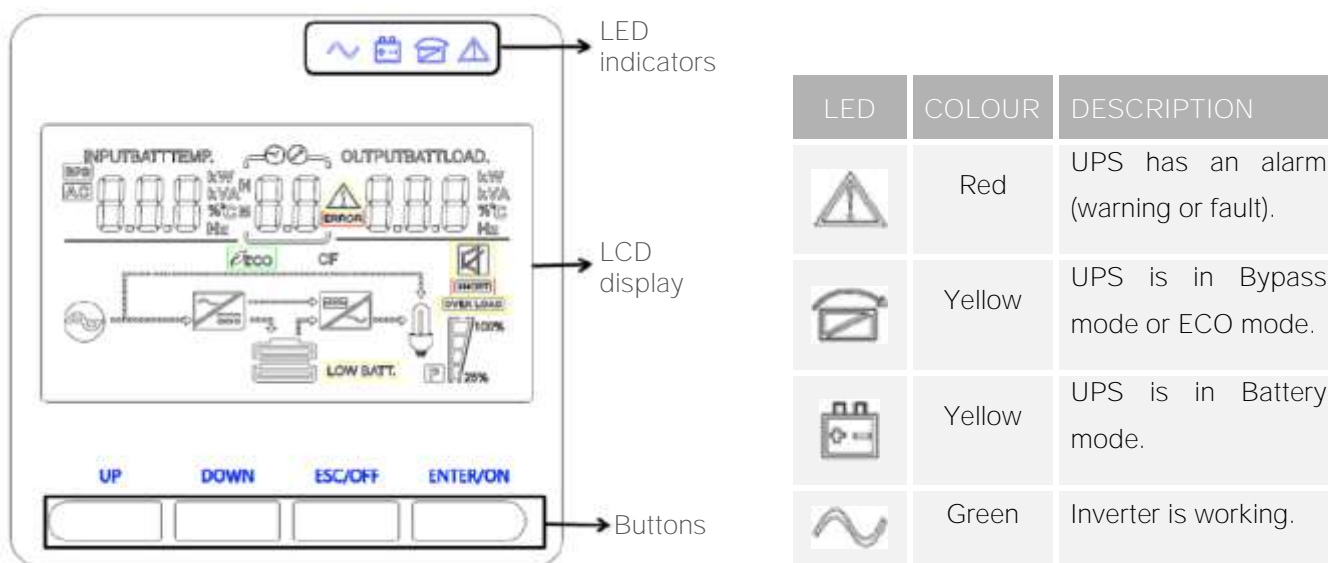

Fig. 4-4 Overview of the operating panel of the UPS

4.3.1 Display information

In the below table is shown and explained all the elements that can appear in the display:

SYMBOL	DESCRIPTION
UPS general information	
	Indicates input, output, battery and UPS general information.
Backup time, alarm and setting information	
	Indicates the remaining backup time when UPS is in battery mode. H: hours, M: minutes
	Indicates warning code (warning symbol blinking).
	Indicates fault code (error symbol lit).
	Indicates parameter number in setting menu.
Battery information	
	Indicates the battery capacity: 0-24 %, 25-49 %, 50-74 % y 75-100 %.
LOW BATT.	Indicates low battery level.

Load information	
	Indicates load level: 0-24 %, 25-50 %, 50-74 % y 75-100 %.
	Indicates overload.
	Indicates the load or the UPS output is short circuited.
Mute operation	
	Indicates that the UPS alarm is muted.
UPS status information	
	Indicates UPS is connected to the mains.
	Indicates rectifier is working.
	Indicates inverter is working.
	Indicates there is voltage at UPS output.
	Indicates UPS is in ECO mode.
	Indicates UPS is in frequency converter mode.
	Indicates not essential outputs are active.

Table 4-1 Display information

4.3.2 Available interfaces in the LCD display

The display provides the following functions (Table 4-2):

ITEM	INTERFACE DESCRIPTION	CONTENT DISPLAYED
01	Input	Voltage & Frequency
02	Output	Voltage & Frequency
03	Bat. +	Voltage & Current
04	Bat. -	Voltage & Current
05	Temperature	PFC/Internal temperature and ambient temperature
06	Load	Current load % referred to nominal
07	Bus voltage	Internal bus voltage ±
08	Software version	DSP version of inverter software
09	Model	Model reference

Table 4-2 Available functions

These are some sample images can be shown on LCD display:

Press “DOWN” button, the UPS goes to next page as shown below (Fig. 4-5 to Fig. 4-12).

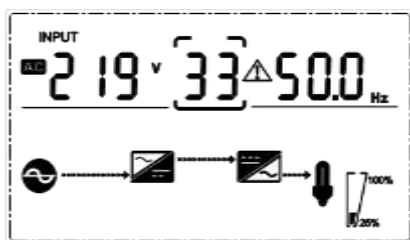

Fig. 4-5 Input voltage

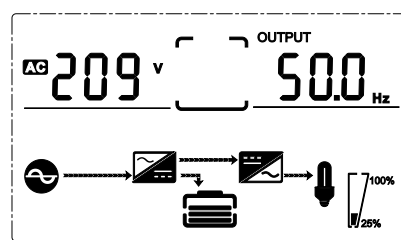

Fig. 4-6 Output voltage

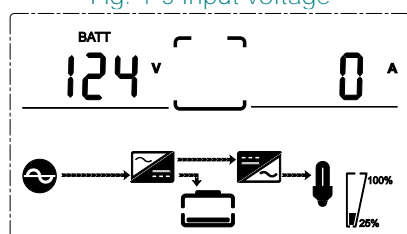

Fig. 4-7 Bat + voltage (Positive)

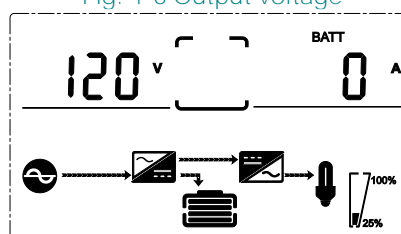

Fig. 4-8 Bat - voltage (Negative)

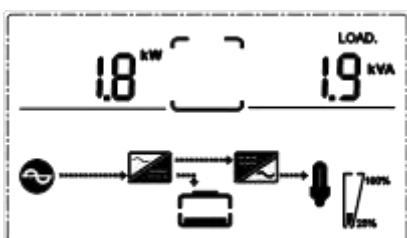

Fig. 4-9 Load

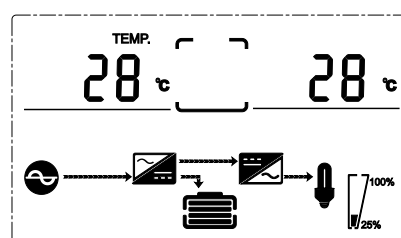

Fig. 4-10 PFC/ Ambient temp. / Internal temperature

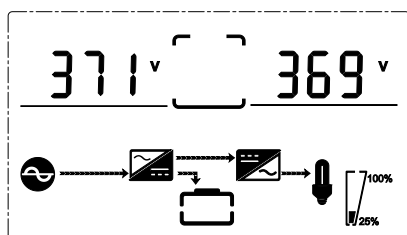

Fig. 4-11 Internal Booster DC bus voltage

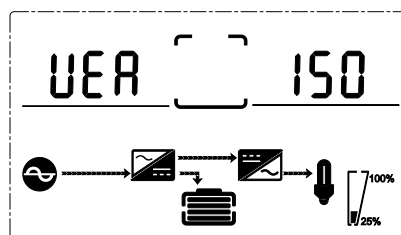

Fig. 4-12 Software version

4.4 Parameters setting

The setting menu is controlled by 4 buttons (ENTER/ON, ESC/OFF, UP, DOWN):

- ENTER /ON --- goes into the setting page and value adjustment;
- UP & DOWN --- for choosing different pages.

After the UPS turn ON, press buttons UP & DOWN for 3 seconds and then goes into the setting interface page. After finishing setting the parameter, press “ESC/OFF” button until exiting out of the current interface.

4.4.1 Operation Mode setting (mod)

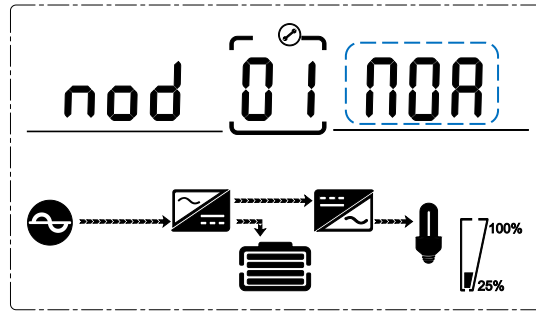

Fig. 4-13 Mode setting

After entering the setting menu, it will be in the default operation mode, and the mode setting line flashing as in above picture (Fig. 4-13).

Operational Status and mode when the UPS is in single mode, it shows "NOR" or "ECO" or "CF", but If the UPS at parallel mode, it shows "PAL" instead. (NOR=Normal / ECO=ECO mode / CF=Frequency Converter mode)

- Use button ENTER/ON to enter and choose different mode. There are 4 different modes: ECO, PAL, NOR or CF.
- Press UP & DOWN to exit, the mode setting and save the current selected settings. Then change to output voltage setting or parallel redundancy quantity setting.

4.4.2 Operation Output voltage setting (OPV)

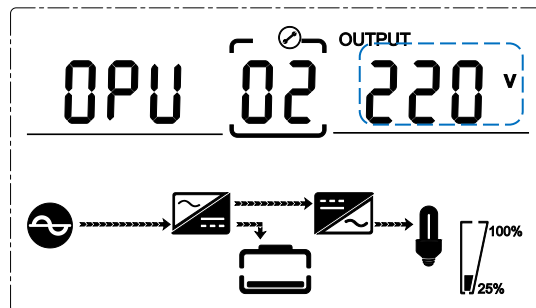

Fig. 4-14 Output voltage setting

When under setting mode, press DOWN or when under frequency setting press UP, it goes to the output voltage setting. The output voltage line flashes as in above picture (Fig. 4-14).

- Use button ENTER/ON to choose a different output voltage. There are 4 different voltages: 208, 220, 230 or 240.
- Press ESC/OFF button to exit the output voltage setting and save the output voltage setting. Then go to mode setting or frequency setting.

NOTE: When inverter is ON, it is necessary to turn off the inverter before setting voltage and frequency level.

4.4.3 Operation Output frequency setting (OPF)

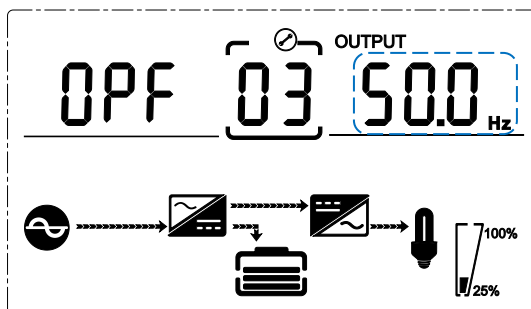

Fig. 4-15 Frequency setting

When under the output voltage setting press DOWN or when under battery capacity setting press UP, it goes to the frequency setting. The frequency line flashes as in above picture (Fig. 4-15).

- Use button ENTER/ON to choose the different frequency. There are 2 different frequency: 50 / 60Hz.
- Press ESC/OFF button to exit the frequency setting (save the frequency setting) and goes to output voltage setting or battery capacity setting.

NOTE: When inverter is ON, it is necessary to turn off the inverter before setting voltage and frequency level.

4.4.4 Battery capacity setting (bAH)

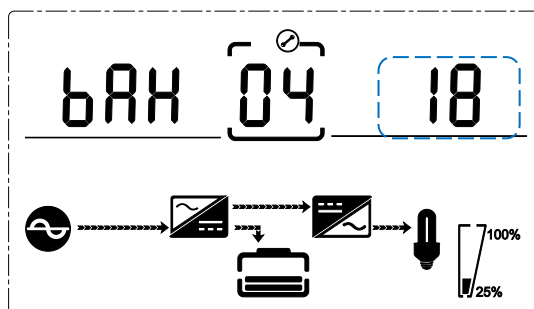

Fig. 4-16 Battery capacity setting

When under the frequency setting press DOWN or when under battery quantity setting press UP, it goes to the battery capacity setting. The battery capacity line flashes as in above picture (Fig. 4-16).

- Use button ENTER/ON to choose the different battery capacity. Battery capacity range is 1-200Ah. (Note: long-press of UP or DOWN can adjustment battery capacity quickly)
- Press ESC/OFF button to exit the battery capacity setting (save the capacity setting) and goes to frequency setting or battery quantity setting.

4.4.5 Battery number/quantity setting (bN)

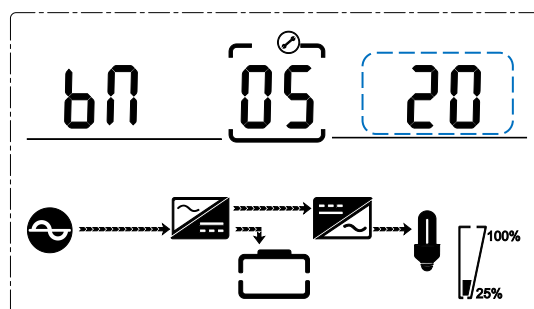

Fig. 4-17 Battery quantity setting

When under the battery capacity setting press DOWN or when under bypass voltage upper limit setting press UP, it goes to the battery quantity setting. The battery quantity line flashes as in above picture.

- Use button ENTER/ON to choose the different battery quantity. Battery quantity range is 16, 18, 20.
- Press ESC/OFF button to exit the battery quantity setting (save the battery quantity setting) and goes to battery capacity setting or bypass voltage upper limit setting.

4.4.6 Bypass High Level switch setting (HLS)

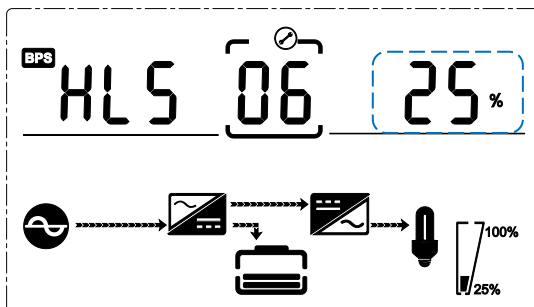

Fig. 4-18 Bypass voltage upper limit setting

When under the battery quantity setting press DOWN or when under bypass voltage lower setting press UP, it goes to the bypass upper limit setting. The bypass upper limit line flashes as in above picture (Fig. 4-18).

- Use button ENTER/ON to set the different bypass voltage upper limit. The bypass voltage upper limit range is 5%, 10%, 15%, 25% (25% only for 220 V output).
- Press ESC/OFF button to exit the bypass voltage upper limit setting (save the bypass voltage upper limit setting) and goes to battery quantity setting or bypass voltage lower limit setting.

4.4.7 Bypass Low Level switch setting (LLS)

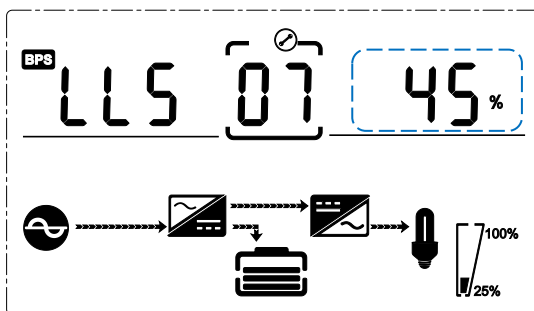

Fig. 4-19 Bypass voltage lower limit setting

When under the bypass voltage upper limit setting press DOWN or when under parallel ID setting press UP, it goes to the bypass lower limit setting. The bypass lower limit line flashes as in above picture (Fig. 4-19).

- Use button ENTER/ON (to set the different bypass voltage lower limit. The bypass voltage lower limit range is 20%, 30%, 45%.
- Press ESC/OFF button to exit the bypass voltage lower limit setting (save the bypass voltage lower limit setting) and goes to bypass upper limit setting or parallel ID setting.

4.4.8 Buzzer Mute Setting (bZ)

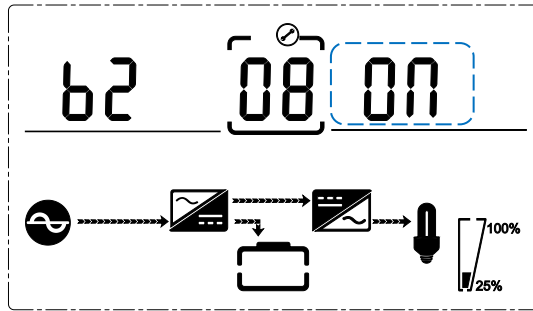

Fig. 4-20 Buzzers mute setting

Press DOWN under bypass voltage lower limit setting or press UP under the parallel ID setting can ENTER the buzzer setting. Now the setting status is flashing as the Fig. 4-20 shows

NOTE: ON= buzzer active; OFF= buzzer mute.

Press ENTER again to stores change, then DOWN button until exit to save the settings.

4.4.9 Battery Test Setting (tSt)

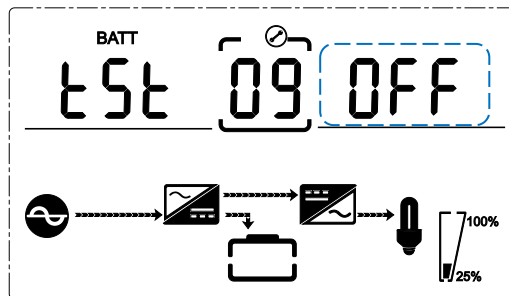

Fig. 4-21 Battery self-test setting

This page is the introduction to the Battery self-test setting (Fig. 4-21). The default Settings is "OFF" when the UPS has no need for battery self-test function. When turn to "ON", batteries can do the self-test automatically per 30 days. Three kinds of Battery Self-test Time can be chose as below.

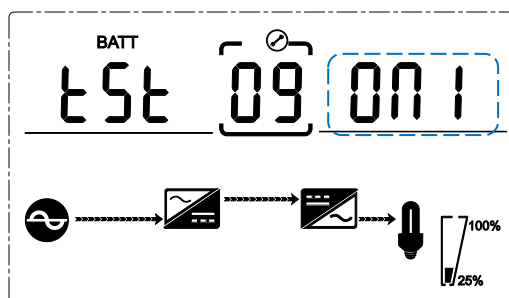

Fig. 4-22 Autotest time On1

When choosing On1, UPS can transfer to Battery Mode automatically per 30 days. And the Battery Self-test Time is 10 seconds (Fig. 4-22).

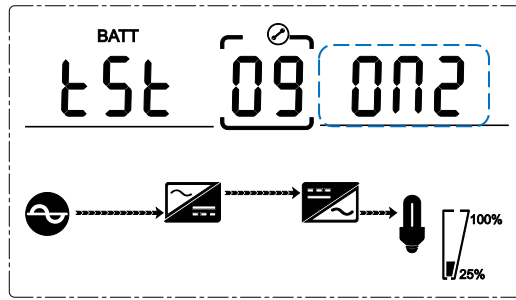

Fig. 4-23 Autotest time On2

When choosing On2, UPS can transfer to Battery Mode automatically per 30 days. And the Battery Self-test Time is 10 minutes (Fig. 4-23).

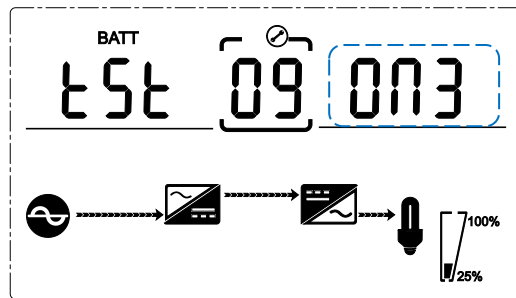

Fig. 4-24 Autotest time On3

When choosing On3, UPS can transfer to Battery Mode automatically per 30 days. And the Battery Self-test Time is to End Of Discharge (EOD) (Fig. 4-24).

4.4.10 Parallel ID setting (PId)

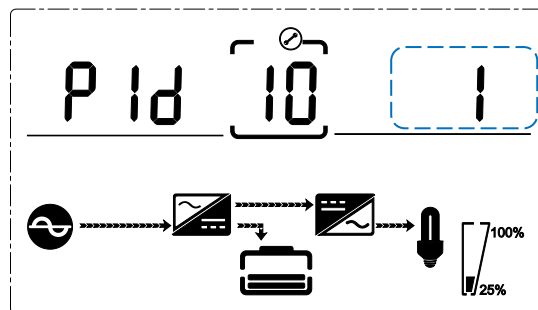

Fig. 4-25 Parallel ID setting

When under the bypass voltage lower limit setting press DOWN or when under parallel quantity setting press UP, it goes to the parallel ID setting. The parallel ID flashes as in above picture (Fig. 4-25).

- Use button ENTER/ON to set the different parallel ID. The parallel ID range is 1~4.
- Press ESC/OFF button to exit the parallel ID setting (save the parallel ID setting) and goes to bypass lower limit setting or parallel quantity setting.

NOTE: Parallel cable cannot be connected when setting the parallel parameters.

4.4.11 Parallel quantity setting (PN)

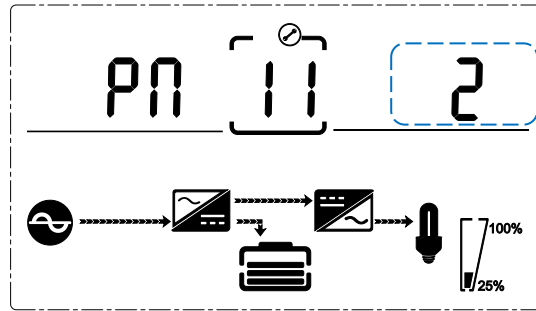

Fig. 4-26 Parallel quantity setting

When under the parallel ID setting press DOWN or when under parallel redundancy quantity setting press UP, it goes to the parallel quantity setting. The parallel quantity flashes as in above picture (Fig. 4-26).

- Use button ENTER/ON to set the parallel quantity. The parallel quantity range is 2-4.
- Press ESC/OFF button to exit the parallel quantity setting (save the parallel quantity setting) and goes to parallel ID setting or parallel redundancy quantity setting.

4.4.12 Parallel redundancy quantity setting (PrN)

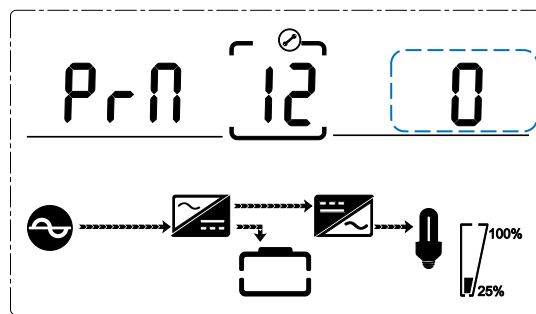

Fig. 4-27 Parallel redundancy quantity setting

When under the parallel quantity setting press DOWN, it goes to the parallel redundancy quantity setting. The parallel redundancy quantity flashes as in above picture (Fig. 4-27).

- Use button ENTER/ON to set the parallel redundancy quantity. The parallel redundancy quantity range is 0-1
- Press UP& DOWN to go to parallel quantity setting, or ESC/OFF button to exit the mode setting. Then UPS LCD panel setting is accomplished.

4.5 List of events and status

As previously mentioned, when an alarm or event arises in the equipment, it is recorded and can be viewed in the Alarms window and in the History window. Below is a list of possible system events (Table 4-3).

ITEM	UPS ALARM WARNING	BUZZER	LED
1	Rectifier Fault	Beep continuously	Fault LED lit
2	Inverter fault (Including Inverter bridge is shorted)	Beep continuously	Fault LED lit
3	Inverter Thyristor short	Beep continuously	Fault LED lit
4	Inverter Thyristor broken	Beep continuously	Fault LED lit
5	Bypass Thyristor short	Beep continuously	Fault LED lit
6	Bypass Thyristor broken	Beep continuously	Fault LED lit
7	Fuse broken	Beep continuously	Fault LED lit
8	Parallel relay fault	Beep continuously	Fault LED lit
9	Fan fault	Beep continuously	Fault LED lit
10	Reserve	Beep continuously	Fault LED lit
11	Auxiliary power fault	Beep continuously	Fault LED lit
12	Initialization fault	Beep continuously	Fault LED lit
13	P-Battery Charger fault	Beep continuously	Fault LED lit
14	N-Battery Charger fault	Beep continuously	Fault LED lit
15	DC Bus over voltage	Beep continuously	Fault LED lit
16	DC Bus below voltage	Beep continuously	Fault LED lit
17	DC bus unbalance	Beep continuously	Fault LED lit
18	Soft start failed	Beep continuously	Fault LED lit
19	Rectifier Over Temperature	Twice per second	Fault LED lit
20	Inverter Over temperature	Twice per second	Fault LED lit
21	Reserve	Twice per second	Fault LED lit
22	Battery reverse	Twice per second	Fault LED lit
23	Cable connection error	Twice per second	Fault LED lit
24	CAN comm. Fault	Twice per second	Fault LED lit
25	Parallel load sharing fault	Twice per second	Fault LED lit
26	Battery over voltage	Once per second	Fault LED blinking
27	Mains Site Wiring Fault	Once per second	Fault LED blinking

28	Bypass Site Wiring Fault	Once per second	Fault LED blinking
29	Output Short-circuit	Once per second	Fault LED blinking
30	Rectifier over current	Once per second	Fault LED blinking
31	Bypass over current	Once per second	BPS LED blinking
32	Overload	Once per second	INV or BPS blinking
33	No battery	Once per second	BATTERY blinking
34	Battery under voltage	Once per second	BATTERY blinking
35	Battery low pre-warning	Once per second	BATTERY blinking
36	Internal Communication Error	Once per second	Bypass LED lit
37	DC component over limit.	Once per 2 seconds	INV blinking
38	Parallel Overload	Once per 2 seconds	INV blinking
39	Mains volt. Abnormal	Once per 2 seconds	BATTERY LED lit
40	Mains freq. abnormal	Once per 2 seconds	BATTERY LED lit
41	Bypass Not Available		BPS blinking
42	Bypass unable to trace		BPS blinking
43	Inverter on invalid		
44	UPS in bypass mode for a long time		
45	EPO (Emergency Power Off activado)	Beep continuously	Fault LED lit

Table 4-3 List of possible events and alarms of ZGR EFFICIENT RT 6 - 10 KVA

**WARNING**

The following process must be performed if UPS is connected with generator:

- *First turn on generator, after it runs stably connect output power of generator to UPS input terminal, then turn on UPS. After UPS turned on, please connect load one-by-one.*
- *It is recommended that the generator capacity is as twice as UPS rated capacity*

5 COMMUNICATIONS

5.1 Communications

5.1.1 Connection of the UPS communication cables

RS-232 or USB cable provided in accessories can be used to connect the UPS with PC

Application: use UPSilon2000 Power Management software

Available functions of the USB

- Monitor UPS power status
- Monitor UPS alarm info
- Monitor UPS running parameters
- Timing off/on setting

5.1.1.1 USB and RS232 communication port definition

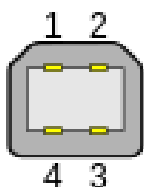

Fig. 5-1 USB male port

UPS USB PORT	DEFINITION
Pin 1 – Vcc	5 Vdc
Pin 2 – D-	USB Data-
Pin 3 – D+	USB Data+
Pin 4 – GND	Ground

Fig. 5-2 USB port pinout

RS-232 communication data format: 2400bps / 8bit / 1bit stop / Parity none

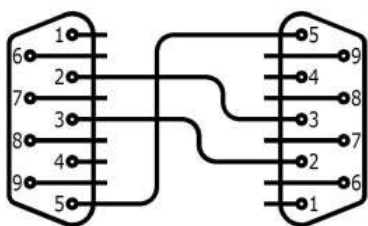

Fig. 5-3 PC to UPS RS232 port

PC RS232 PORT	UPS RS232 PORT	DEFINITION
Pin 2 – RX	Pin 2 – TX	UPS send PC receive
Pin 3 – TX	Pin 3 – RX	PC send UPS receive
Pin 5 - GND	Pin 5 – GND	Ground

Fig. 5-4 Connections between PC RS232 port and UPS RS232 port

USB virtual serial port data format: 9600bps / 8bit / 1bit stop / Parity none

5.2 Intelligent slot

The UPS is equipped with a slot that is designed optionally for either SNMP/Modbus or dry contact cards. Only 1 slot is available on this UPS family, so you need to determine what kind of card to install.

This intelligent slot is Plug&Play, so once inserted, communication will be established without the need for any adjustment on the UPS display.



Fig. 5-5 SNMP/Modbus card view

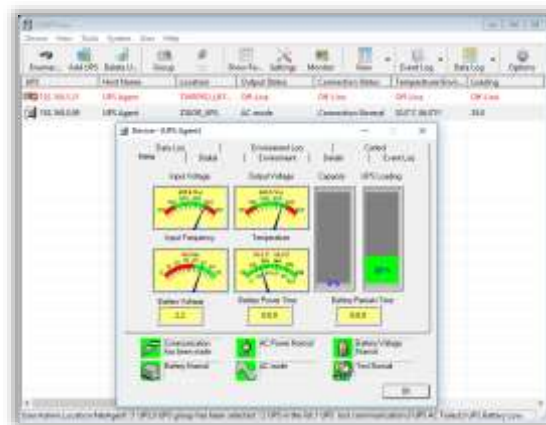

Fig. 5-6 SNMPview software image

5.2.1 TCP-IP communications card (optional)

The SNMP/Modbus communications card has an RJ45 female connector to allow advanced UPS management remotely via an Ethernet network.

It also has a mini-USB connection to optionally connect a concentrator (HUB) of environmental sensors with sound alarm. (Temperature, Humidity, Flood,...)

IMPORTANT: INTERNET SECURITY

On newer models these cards includes several advanced security protocols such as HTTPS, SSL, TLS, SNMP v3.

If you are going to expose this card to the internet, you must ensure that you have other protection/security systems that prevent vulnerabilities from being traced, and in any case disable the functionalities that you do not wish to use.

ZIGOR cannot be held responsible for damage caused by cyber-attacks if exposed directly to the internet.

The most common UPS monitoring protocols are included; SNMP and Modbus TCP/IP.

This card, autonomously and without the need for additional software, allows notifications to be sent via e-mail of different events that occur in the UPS. For example, when there is a loss of main AC power supply, an overload due to a short circuit at the output, a defect in the device itself, and others. Even send daily reports of important events.

The most advanced model of this card also allows notifications via TELEGRAM, SKYPE, LINE.

It includes BACnet protocol support, GigaLAN connectivity (1000Mbit), more notifications and selectable recipients and up to 13 languages.

All functionalities can be managed via an integrated web server that can be accessed from any web browser (Safari, Edge, Chrome, Firefox, Edge and others).

A proprietary software package (NetAgent) compatible with various Operating Systems (Windows, MAC, Linux, VMware) is also available to monitor / manage one or multiple UPS simultaneously.

(1) NetAgent updates are limited and there may be incompatibilities on newer OS.

IMPORTANT: ELECTRONIC SECURITY

This card only allows monitoring and modification of certain parameters that do not affect the electronic operation of the UPS.

It is not possible to modify the most important electronic operating settings defined by the display. (voltage, frequency, type and capacity of battery)

To avoid damaging the UPS, these settings must only be made manually and in person by authorised and experienced personnel.

5.2.2 Dry-contact relay card (optional)

Dry contact card has a terminal connector and could be used to monitor UPS status in real time through relay contacts.

Consists of 6 non-programmable contacts with both terminals. Norm.Open (NO) and Norm.Closed (NC)

The programmed functions are as follows:

PIN	UPS ONLINE (NO ALARMS)	Function	EXAMPLE (MAINS FAIL)
1	COM	Common terminal	
1-2		Inverter mode. ONLINE active	
1-3		AC mains lost (UPS in battery mode)	
1-4			
1-5		Low battery	
1-6			
1-7		Any alarm active	
1-8			
1-9		Bypass active (unprotected load)	
1-10			
1-11		Internal UPS critical fail	
1-12			

Table 5-1 Dry-contact terminals function



Fig. 5-7 Dry-contact card image

For more information or support, please consult its respective manual or contact our Customer Service Support (sac@zigor.com)

5.3 UPS remote access

If you have purchased a communications card:

- Connect the Ethernet cable to establish communication within your LAN.
 - Locate and run the NETILITY software (Fig. 5-8)
 - It will search your LAN for any compatible communications cards.
 - If there are multiple cards detected, you will see a list of all of them.
 - By default, DHCP service is enabled for automatic IP assignment.
- Once detected, you will be able to view the IP, MAC address, serial number and firmware version.
- Select the "Launch Web" icon and you will access the card management webserver.



Fig. 5-8 Netility software main screen

5.3.1 IP manual assignment

Using the "Network settings" icon, you can manually assign the IP address to your card, modify the HTTP/HTTPS/Telnet/SSH management ports and assign a main access password to the webserver.

PASSWORD RESET

To reset and disable the password you must remove the card and on bottom PCB will be a model label, then you will see the reset password (the password is unique and non-transferable for each card).

Access the IP of the card <http://xxx.xxx.xxx.xxx/password.cgi> and on the screen that will appear, as user ID: admin and as password: (see label password).

If you lose or do not have this label it will not be possible to reset the card and you will have to buy a new one.

5.3.2 NetAgent webserver main screen

When accessing the webserver through the Netility application or directly if you already know the IP address, you will find a main screen similar to the one shown in (Fig. 5-9).



Fig. 5-9 NetAgent main webserver screen

- In the "Configuration" menu you can find the main settings of the card (Fig. 5-10).



Fig. 5-10 Configuration menu

Note: The available options may differ depending on the card model purchased or may change without prior notice.

For more information or support, please consult its respective manual or contact our Customer Service Support (sac@zigor.com)

6 TROUBLESHOOTING

6.1 Malfunctions of ZGR EFFICIENT RT 6 - 10 KVA

ZIGOR recommends that, in case of any anomaly, strange noise or supposed malfunction, the equipment should be shut down and ZIGOR customer service should be contacted.

In case the UPS cannot work normally, it might be wrong in installation, wiring or operation. Please check these aspects first. Besides, ZGR EFFICIENT RT 6 – 10 KVA system has a specific section of active system events, in the Events menu (section 3.4).

The following table summarizes different anomalous conditions and their possible solution (Table 6-1).

SYMPTOMS	POSSIBLE CAUSES	SOLUTIONS
Battery LED flashes	Battery low voltage or battery disconnected	Check UPS battery, connect battery well, if battery damaged, replace it
Mains normal, but UPS has no input	UPS input breaker open circuit	Press the breaker for reset
Short back up time	Battery not fully charged	Keep UPS connecting with mains power for more than 8 hours, to recharge battery
	UPS overload	Check the usage of loads, remove some redundant devices
	Battery aged	When replace battery, contact ZIGOR to get battery and relative assembly
No AC power, UPS cannot start-up after pressing the ON key	Press the ON key for a short time	Press and hold the ON key for more than one second to start the UPS
	UPS has no battery connected or battery voltage low and too many loads connected	Connect UPS battery well, if battery voltage low, please turn off UPS and remove some loads, then start UPS
	Fault occurs inside UPS	Contact ZIGOR for servicing

Table 6-1 Troubleshooting

Given the complexity of the equipment, when a serious error occurs and causes the equipment to stop, ZIGOR customer service should be contacted to assist you step-by-step to your resolution by providing the information requested.

For more information, contact: www.zigor.com
sac@zigor.com

7 MAINTENANCE

You can ask for an offer to ZIGOR in order to perform a basic maintenance of this equipment, so that it can prolong the life of the system.

In order to guarantee the correct operation of the ZGR EFFICIENT RT 6 - 10 KVA, it is necessary to carry out a number of maintenance tasks. These tasks enable resolving defects before breakdowns occur and to ensure correct operation of active and passive safety devices.

The frequency of maintenance tasks is dependent upon the location and the atmospheric conditions. The air quality (temperature, dust in suspension, etc.) has a great influence on the amount of maintenance work to be done in order to maintain the functionalities of the equipment within an acceptable level of uncertainty. That is, for example, if the air contains a great amount of dust in suspension, the maintenance work must be carried out more frequently than the standard frequency indicated.

The recommended maintenance tasks in accordance with frequency are as follows:

- Monthly:
 - Visual control of correct operation:
 - LEDs and/or LCD indicating correct operation.
 - Values within margins.
 - No active event/alarm.
 - Control of the event history, searching for sporadic or repetitive failures.
 - Check nothing blocks the ventilation of the front, rear and side panel and the case bottom.
- 6 monthly:
 - Check on the correct ventilation of the location.
 - Cleaning of the equipment's air inlet filters.
 - Removal of foreign bodies both in the air inlet and outlet.
 - Visual verification of the status of connecting wires, rusting, damage to insulation, etc.
- Annually:
 - Cleaning and blowing of electronics.
 - Checking the tightening and condition of the cables, power and signal.
 - Visual checking.
 - Retightening of the connections.
 - Check for colour changes or deformations due to hot spots.
 - Review of hardware (tightening) and wiring (possible rodent involvement or similar).
 - Cleaning control and water filtration of the room where the system is located.
 - Connection of the external AC protections of the equipment (switches, thermal magnets, etc.) and complete controlled start of the equipment.

For some of these maintenance tasks, shutdowns and disconnections must be made.



Incorrect maintenance can render the warranty null and void.

- Fan: Continual working time of fan is 20000 to 40000 hours. It will be shorter as temperature raises. Please check the fan periodically, make sure there is wind blowing out from it.
- UPS status checking:
 - Check to see if there is any fault occurred, fault indicator is ON or any alarm.
 - Please find the cause if the UPS is working in bypass mode.
 - If the UPS is working in battery mode, make sure it is normal; on the contrary, please find out the root cause, such as Utility Failure or self-check of battery.

The rest of the installation must also be maintained adequately. The maintenance tasks to be carried out shall depend on the different elements that make up the installation, emergency generator and cabling. The battery requires special attention.

7.1 Battery maintenance

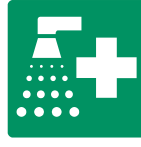

Efficient maintenance lengthens the service life of batteries and ensures that the unit operates correctly.

Placing the batteries correctly so that all their elements can be easily reached facilitates maintenance. Maintenance consists of checking the following aspects:

- Cleanliness: The elements, their connections and supports must be kept clean and dry. It is recommended to protect the terminals and metal connections with diluted vaseline. Do not use cleaning products containing solvents and/or harmful substances for cleaning elements with plastic containers.
- Connections and terminals: Check the tightness of nuts on the poles of elements as well as the tightness of the electrical connection with at regular intervals of approximately 12 months.
- Checking voltages: Check the voltages of elements in order to detect any possible anomalies in these.

There are sealed lead acid maintenance free batteries connected to this models. Battery life depends on environment temperature and discharge/charge cycles, it will be shortened if temperature raised or deep discharged. Periodical maintenance is required so as to keep battery in good condition.

- 1) The most proper working temperature is 15 to 25 °C.
- 2) Avoid small discharging current. **Don't let UPS work in battery mode continuously for 24 hours.**
- 3) Charge battery for at least 12 hours every 3 months if it is free of operation. If the environment temperature is high, charge it once every 2 months.
- 4) For extended backup models, check and clean the battery connectors periodically.

If backup time has become much less than before, or there is battery fault displayed on the LCD, please contact ZIGOR to confirm whether the batteries are needed to be replaced or not.



WARNING

Before replacing batteries, first please turn off the UPS and break off the mains. Remove your metallic adornment such as finger ring, watch and so on.

When replace batteries, please use the screwdriver with insulating handle. Do not lay the tools or metallic goods on the battery.

Never reverse or short-circuit between the battery anode and cathode.

Do not smoke, light a fire or generate sparks near batteries during recharging as there is a risk of fire and/or explosion.

For cleaning, do not use synthetic material clothes or sponges. Keep batteries clean and dry at all times. Protect them against dirt, dust, metal shavings, etc.

8 TECHNICAL SPECIFICATIONS

Model	ZGR EFFICIENT RT 6	ZGR EFFICIENT RT 10
Power	6 kVA / 6 kW	10 kVA / 10 kW
INPUT ELECTRICAL CHARACTERISTICS		
Phases	Single-phase with ground	
Nominal Input voltage	208/220/230/240 Vac (adjustable)	
Input voltage Range	120 – 276 Vac	
Frequency	50 – 60 Hz (auto detect)	
Frequency range	45 ~ 55 Hz / 54 ~ 66 Hz	
Power Factor	≥ 0,99 (100% load at nominal input voltage)	
Rango de Voltaje Bypass	220 Vac max.: 10 %, 15 %, 20 % ò 25 %, default 25 %	
	230 Vac max.: 10 %, 15 % ó 20 %, default +20 % 240 Vac max.: +10 % ó 15%, default +15 % min.: 20 %, 30 % ó 45 %, default 45 %	
Bypass voltage Range	± 1 %, ± 2 %, ± 4 %, ± 5 %, ± 10 %	
THDI	≤ 3 % (100 % lineal load, input THDV ≤ 1 %)	
	≤ 5 % (100 % non lineal load, input THDV ≤ 1 %)	
Generator input	Support	
OUTPUT ELECTRICAL CHARACTERISTICS		
Nominal voltage output	208/220/230/240 Vac	
Output type	Single phase + Ground	
Voltage regulation	± 1,0 %	
Power factor	1	
Waveform	Pure Sinewave	
Harmonic Distorsion (THD)	≤ 2 % al 100 % lineal load	
	≤ 5 % al 100 % non lineal load	
Rating frequency	50 Hz/60 Hz ± 0,1 %	
Peak value factor	3:1	
Efficiency	≥ 93 %	
DC Component	≤ 500 mV	
BATTERIES		
Battery type	Sealed lead VRLA	
Battery number	16/18/20 uds. (adjustable)	
Charge model	Boost charge or float charge auto switch	
Charge time	Boost charge up to 20 Hr (max)	
Charge current (A)	10 A (adjustable)	
COMMUNICATIONS		
Monitorization	LCD + LED	
Communications	USB or RS232 , SNMP (optional) , dry contacts (optional)	
OTHERS		
Frequency track speed	1 Hz/s	
Overload	105 % ~ 110 %, 10 min	
	110 % ~ 130 %, 1 min	
	≥ 130 %, 200 ms	
Dynamic response	5,0 %	
	20 ms	

Switch time	AC mode <-> batt mode	0 ms	
	Inverter <-> bypass	0 ms	
		Unlock: <15 ms (50 Hz), <13,33 ms (60 Hz)	
Max input voltage	320 V AC, 1 Hr		
MTBF	250.000 Hr 1 + 1 400.000 Hr		
MTTR	30 min		
Isolation resistance	> 2 M Ω (500 V DC)		
Isolation intension	2820 Vdc, < 3,5 mA, 1 min		
Surge	According to IEC60664-1 1.2/50uS+8/20uS 6kV/3kA		
Parallel circumfluence	1+1 \leq 8 %, N+1 \leq 3 %		
Parallel equal current	1+1 \leq 8 %, N+1 \leq 10%		
MECHANICAL AND ENVIRONMENTAL CHARACTERISTICS			
Operation temperature	0 °C – 40 °C		
Storage temperature	-25 °C – 50 °C		
Relative humidity	20 - 90 % (without condensation)		
Altitude without power reduction	< 1500 m		
Cooling	Forced ventilation		
Protection degree	IP 20		
Noise level	< 55 dB a 1m		
Dimensions (W x D x H)	440 x 88 x 625 mm		
Approx. weight	14 kg	18 kg	
Mounting type	Rack		
STANDARDS			
Marks	CE		
Directives	EN 60950-1 , EN 62040-1, EN 62040-2, EN 62040-3, ROHS		
	IEC61000-4-2,IEC61000-4-3,IEC61000-4-4, IEC61000-4-5,IEC61000-4-6,IEC61000-4-8		

- The technical specifications may be modified without prior notice.
- For any other technical need or modification of existing ones, consult ZIGOR

9 STANDARDS

ZGR EFFICIENT RT 6 - 10 KVA model described in this manual comply with the following European regulations:

- I. LVD Security directive LVD 2014/35/EU about Uninterruptible Power Supply (UPS)
Standard: EN/IEC 62040-1: 2019
- II. EMC directive 2014/30/EU about electromagnetic compatibility (EMC)
Standard: EN/IEC 62040-2:2018
EN 61000-3-12:2011
EN 61000-3-11:2000
- III. Conformity:
UPS Classification: EN 62040-3:2011



10 WARRANTY

Unless otherwise agreed, ZIGOR guarantees that ZGR EFFICIENT RT 6 - 10 KVA units leave the factory in perfect working order and free of any defects for a period of 12 months to be counted as of the date of sale of the apparatus, shown in the delivery note and/or invoice.

ZIGOR will guarantee to the Buyer, the proper functioning against manufacturing and/or workmanship defects. This Warranty includes, whenever the circumstances of good use on the equipment, replace, repair (workmanship included) or refund the purchase price as paid by the customer within the above specified period according to the type of defect and are only and exclusive remedies guaranteed under this Limited Warranty.

The replacement of spare parts, if required, will be made with other new or repaired parts and the replaced ones will become property of ZIGOR.

Unless otherwise agreed, it's not included any assistance and / or displacement. If demanded by the buyer, he'll be held responsible for it.

The customer will be free of charge provided the cause of equipment failure due to defective material thereof, without being affected by the exclusion of warranty causes described in the next section. In any other circumstances be charged the amount of economic displacement.

The following situations will cancel the guarantee of the product:

- Faults due to improper handling of the product, according to the operating instructions, misuse, default grid or by storm.
- Improper use of the equipment according to the Operating Manual and without respecting the original characteristics of the equipment, without ZIGOR's **authorization**.
- Installation in a place/ environment that does not meet the requirements indicated in the Operating annual referring to the Installation Conditions.
- When the customer not clearly proves the systematic realization of regular maintenance operations described in the Operating Manual.
- Equipment deterioration due to external agents (water, dirt, animals, etc.)
- Damages caused by accident, theft, fire, inadmissible atmospheric conditions, external agents (animals, insects, etc.) or natural disasters.
- In case of any intervention and/or repair by an unauthorised Technical Service, without ZIGOR's authorization.
- The use of equipment or accessories, not sell and/or installed by ZIGOR or their Authorised Technical Service.
- Environmental Operating Conditions out of range.

When the unit is equipped with lead-acid batteries, it must be considered the following precautions:

Those elements are fully charged before shipment. They can be stored for up 2 years provided that they are charged at minimum intervals of 6 months during their storage.

The installation of elements inside the unit by personnel other than those authorised by ZIGOR, shall render the warranty null and void. ZIGOR will not accept responsibility for the repair of equipment if any of the seals installed for internal checks is broken.

The validity of this guarantee is limited to the proper use of the equipment according to the Operating Manual and while respected the original characteristics of the equipment.

The Spanish Standardisation and Certification Association (AENOR) certifies that the "Quality Assurance " and "Environmental Management Systems" adopted by ZIGOR CORPORACIÓN, S.A. for the design, development, production and after sales service for electronic equipment for the conversion of direct and alternating current as well as electronic projections, communications systems, telemanagement applications and electrical and electronic turnkey projects, is an agreement with the requirements of the Spanish Standards UNE-EN ISO 9001:2015 and UNE-EN ISO 14001:2015 respectively.





Zigor Corporación
Portal de Gamarra 28- 01013
Vitoria-Gasteiz Álava/Spain
+34 945 21 46 00
www.zigor.com

*Consulte nuestra web para contactar con la red de delegaciones comerciales
Refer to our website in order to contact the commercial branches network
Veuillez consulter notre page web pour contacter nos délégations commerciales
Consulte a nossa web para contatar com a rede de degações comerciais*