

## Operation Manual



# ZGR TOWER PRO 1 – 3 KVA

Online single-phase UPS



## INDEX

1	PRECAUTIONS .....	5
1.1	General precautions .....	5
1.2	Storage precautions .....	6
1.3	Environmental precautions .....	7
1.4	Precautions on the transportation of the unit .....	7
2	GENERAL DESCRIPTION .....	8
2.1	Introduction .....	8
2.2	Main characteristics .....	9
2.3	Optional characteristics .....	10
2.4	Construction of the unit .....	10
3	INSTALLATION .....	11
3.1	Reception of material .....	11
3.2	Installation conditions .....	11
3.3	Connections .....	11
3.3.1	External battery connections (only “LBT” long backup time models) .....	13
4	OPERATION OF ZGR TOWER PRO 1 – 3 KVA .....	16
4.1	Control panel .....	16
4.1.1	LED indicators .....	16
4.1.2	Display information .....	17
4.1.3	Alarm list .....	18
4.1.4	Pushbutton functions .....	20
4.1.5	UPS setting menu .....	20
4.2	Operation modes .....	22
4.2.1	Normal mode (ONLINE) .....	22
4.2.2	Battery mode .....	22
4.2.3	Bypass mode .....	23
4.2.4	Standby mode .....	23
4.2.5	ECO mode .....	23
4.2.6	Frequency converter mode .....	24
4.3	Operation procedures .....	24
4.3.1	Before Start-up .....	24
4.3.2	First Start-up .....	24
4.3.3	Cold-Start: Start-up without mains .....	25
4.3.4	Regular starts and stops .....	25
4.3.5	Switching off for a long period .....	25
4.3.6	Battery mode operation .....	26
4.3.7	Battery test .....	26
4.3.8	Mute the buzzer .....	27
4.3.9	Operation in warning status .....	27
4.3.10	Operation in fault status .....	27
5	COMMUNICATIONS .....	28
5.1	USB port .....	28
5.2	RS232 port .....	28

5.3	Intelligent slot .....	29
5.3.1	TCP-IP communications cards (optional) .....	29
5.3.2	Dry-contact relay card (optional).....	30
5.4	UPS remote access .....	31
5.4.1	IP manual assignment.....	31
5.4.2	NetAgent webserver main screen.....	31
6	TROUBLESHOOTING.....	33
6.1	Malfunctions of ZGR TOWER PRO 1 – 3 KVA.....	33
7	MAINTENANCE .....	34
7.1	Maintaining the electronic system .....	34
7.2	Battery maintenance .....	35
7.2.1	Battery replacement.....	36
8	TECHNICAL SPECIFICATIONS.....	37
9	STANDARDS.....	39
10	WARRANTY.....	40

**© 2024, ZIGOR**

*All rights reserved. The total or partial reproduction of this User Manual, or its transmission of any type or by any means, be this mechanical or electronic, by means of photocopies, registration or other information storage or recovery procedure, without the permission of the editor, is totally forbidden.*

*The contents of this manual are exact at the time it was printed. However, with the intention of complying with our aim of continuous development and improvement, the manufacturer reserves the right to change the specifications of the product, its operation or the contents of the Operating Manual without prior warning.*

## 1 PRECAUTIONS

### 1.1 General precautions

For your own safety and that of the unit, you must read and understand the instructions contained in this document before starting work.

Keep these instructions in a place accessible to all the personnel who work with the unit so that they can be consulted.

Only expert and duly authorised personnel may operate our units.



Danger warnings. When handling or accessing the interior of the ZGR TOWER PRO 1 – 3 KVA, please remember that some parts may be live. Pay special attention to soldering points, printed circuits, connecting terminals, relay contacts, etc. Before opening the equipment, disconnect the voltage of all poles (both alternating and direct) and wait at least 5 minutes for the internal condensers to discharge.

Arbitrary modifications are forbidden. The unit must not be subjected to any modification regarding its construction or safety without **ZIGOR's** express consent. Any modification will free ZIGOR of any responsibility for any damage caused as a result of the modification. In particular, all repair work, soldering of printed circuit boards and replacing of components, modules and printed circuit boards, without the express authorisation of ZIGOR, is forbidden. Should spare parts be used, only ZIGOR original parts shall be utilised.

Use the unit for the purpose for which it was designed. The system supplied must be used only for the purpose for which it was designed. Any other use is strictly forbidden. ZIGOR cannot accept responsibility for any damage that might result from its use for any other purpose. In such cases, the user shall assume exclusive responsibility for any risk. The use for which the unit was designed is defined in the documentation. The system shall be exposed only to admissible environmental conditions. These are defined in the technical details provided for the equipment.

ZIGOR accepts no responsibility for any inadequate, negligent or incorrect installation of the equipment.



**WARNING**

*This supply equipment contains a lethal voltage. Comply with the instructions set out in this manual to avoid any risk of electrical shock.*

Please follow the indications set out below to operate under conditions of complete safety:

- The System must be checked once the installation has been completed by a qualified technician and before being put into operation. Should these indications not be adhered to, the warranty shall be considered null and void.
- These units do not contain parts usable for other purposes by the user.
- Do not power up the device before a technician has checked it.
- Given the risk of electric shock or burns, do not try to open the device.
- Work inside the cabinet should be undertaken only by qualified personnel who are familiar with the safety measures to be applied and the specific technical characteristics of the unit.
- The unit does not contain any user repairable or replaceable elements. In the case of any malfunction or problems operating the unit, please contact ZIGOR.
- Do not place the system near power magnets as this might cause a malfunction.
- Do not block or cover the ventilation grills in the housing.
- The ZGR TOWER PRO 1 – 3 KVA is designed in accordance with current Spanish legislation. Check these regulations against those corresponding to the country in which the unit is to be installed and against the most restrictive regulations of the electricity supplier.
- All user controls are accessible from the exterior.
- This system has been designed for industrial use and not for domestic-commercial use.

- Even though all the safety systems are in place, before touching any working parts, you must check that they are not live.
- If any liquid is spilt accidentally on the System, disconnect it and call to ZIGOR support.
- During assembly work, start-up or maintenance, wear goggles to avoid any damage to your eyes due to accidental electric arcing.
- Use only insulated tools.
- The unit must be protected against rain and excess humidity and installed in a clean atmosphere, without inflammable liquids, gases or oxidising substances.
- The battery may pose a risk of electric shock or burns due to its high short circuit current.
- If the batteries lose electrolyte or are physically damaged, they must be placed in a container in resistant to corrosive liquids (acids or alkaline according to the type of battery) and prepared in accordance with local regulations.
- If the electrolyte comes into contact with the skin, the affected area must be washed immediately with clean water.
- For the sake of human being safety, please well earth the UPS before starting it.
- Do not throw batteries into a fire as they may explode.
- UPS models with internal batteries can be powered even when the UPS input is not connected to the mains.
- Do not disconnect the input from the UPS and make sure the UPS is completely off before moving it or reconfiguring the connection; otherwise, there is a risk of electric shock.
- Only authorized personnel should repair or install the batteries.
- Should you have any problems with the contents of this manual, you must ask ZIGOR for assistance.

## 1.2 Storage precautions

The store where the material is kept must protect the material from the elements, risk of flooding or contact with water.

The material shall be protected from any risk of overheating due to exposure to direct sunlight or through windows.

The UPS has lead batteries. The temperature has an influence on auto-discharge and on the service life of the batteries. Therefore, it is essential to store them in as cool an atmosphere as possible.

The recommended storage temperature is from 15°C to 25°C. An increase of 10°C can reduce the service life of the battery by 50%. The recommended relative humidity is from 30% to 90%.

To avoid any risk of mechanical shock, do not stack the packages. These must be placed in accordance with the silkscreen printed details on the boxes used for packaging.

For prolonged periods of storage, voltages must be controlled at the following intervals:

- Storage at 20°C: Every 3 months.
- Storage at 30°C: Every 2 months.

Disconnect the battery if this is to be shut down for a long time.



**WARNING**

*Any failure to respect these precautions may render the product warranty null and void.*

### 1.3 Environmental precautions



*Dispose of the packaging in an ecological way: ZIGOR, based on the exceptions detailed in the First Additional Provision of Law 11/1997 on commercial or industrial packaging, informs that the final holder of the waste of used containers and packaging, as responsible for them, you must deliver them in appropriate conditions for reuse, to an authorized recuperator, recycler or re-valuer.*

*The subsets of the system are recyclable products and cannot be treated as household / municipal waste at the end of its useful life.*

*To preserve the environment, manage them in accordance with current environmental regulations and requirements in each country or community. In case of doubt, consult the manufacturer.*



*Correct product disposal: This electrical-electronic device (AEE) is marked with the symbol of compliance with the European Directive 2012/19 / EU (WEEE) regarding used electrical and electronic equipment (Waste electrical and electronic equipment WEEE, RD 110/2015).*

*The Directive provides the general framework valid throughout the European Union for the removal and reuse of waste from EEE.*

*To dispose of this product and ensure its proper management, follow the current local environmental legislation and regulations. In this way it will contribute to conserve the*

*Correct disposal of batteries: Used batteries are reusable consumer products and a recycling process must be carried out.*

*Used batteries that do not go through the recycling process must be disposed of according to the instructions regarding special waste, in accordance with the regulations and environmental requirements in force in each country or community. This requirement applies in the European Union and in those places where separate collection systems are available.*



*In case of doubt, consult the manufacturer.*



*In this way it will contribute to conserve the environment.*

### 1.4 Precautions on the transportation of the unit

Please transport the UPS system only in the original package to protect against shock and impact. The procedure to transport of the UPS to the final location should follow the procedure:

1. Use a pallet truck to transport the UPS to the installation position.
2. Check the UPS packing.
3. **Don't lean the UPS when moving it out from the packaging.**
4. Check the appearance to see if the UPS is damaged or not during the transportation, do not switch on the UPS if any damage found. Please contact the dealer right away.
5. Check the accessories according to the packing list and contact the dealer in case of missing parts.

## 2 GENERAL DESCRIPTION

### 2.1 Introduction

You have just purchased an Uninterrupted Power Supply (UPS) System.

In order to get highest efficiency from your product and to ensure a safe use, we recommend that you strictly read and retain this operating manual for later reference. In addition, do not hesitate to contact customer service for more detailed information and/or assistance (sac@zigor.com).

The UPS will be connected between the load and the grid. The purpose of this device is to provide the load with controlled power for each load and input supply condition. The power provided by the UPS will be protected from all variations in grid's voltage and frequency by supplying electrical power to the load in a stable, controlled and disturbance-free manner.

ZGR TOWER PRO 1-3 KVA series are “online” double conversion and high frequency type UPS units in tower, connected to the single phase network, and supply an output voltage which is also single phase. These consist of an electronic high frequency rectifier with active power factor corrector, which supplies a inverter stage, a battery charging circuit and an output filter that provides quality, disturbance/harmonic-free output.

In case of a mains failure, the load supply is guaranteed by the battery power supply for a backup time that varies depending on the capacity of batteries used. If mains voltage is recovered during the backup time, UPS will return to normal mode automatically and continue supplying power to loads. Meanwhile, batteries are charged as well.

In the case of an overload or breakdown of one of the UPS stages, the UPS has a bypass that guarantees the power supply to the load uninterruptedly. Once overload is recovered or the breakdown is repaired, load is transferred back to normal mode.

A microprocessor is responsible for controlling the different circuits and for presenting the UPS status through a liquid crystal display (LCD) and LED indicators.

The UPS can be monitored remotely via a computer by using several communication protocols.

System used in ZGR TOWER PRO 1-3 KVA uninterruptible power supply is shown in the following simple block diagram.

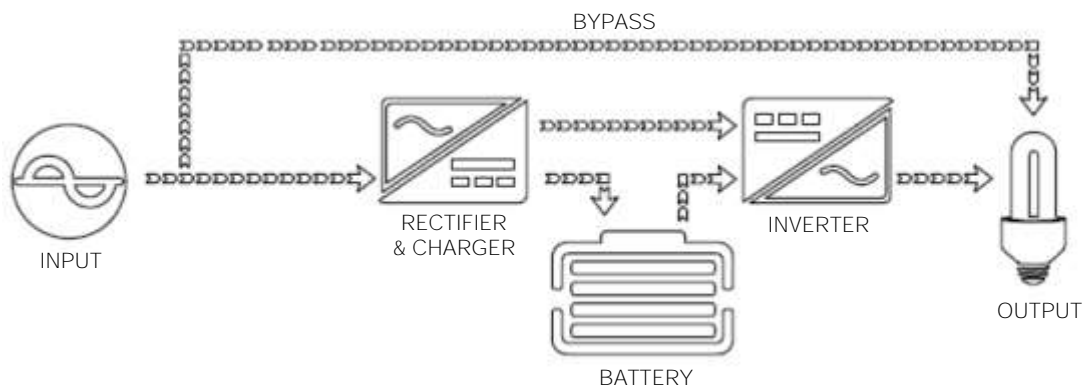

Fig. 2-1 Simplified diagram of ZGR TOWER PRO 1-3 KVA



The complete range is shown in the following table:

MODEL	POWER	BATTERY PLACEMENT
ZGR TOWER PRO 1 KVA	1 KVA	Internal
ZGR TOWER PRO 2 KVA	2 KVA	
ZGR TOWER PRO 3 KVA	3 KVA	
ZGR TOWER PRO 1 KVA LBT	1 KVA	External
ZGR TOWER PRO 2 KVA LBT	2 KVA	
ZGR TOWER PRO 3 KVA LBT	3 KVA	

Table 2-1 ZGR TOWER PRO 1-3 KVA series range

The indication “LBT” in each power model refers to the specific model of UPS that the system has not any battery inside them but with a reinforced battery charger. These models are normally used for high backups and they are accompanied by battery cabinets.

## 2.2 Main characteristics

- Low distortion sinusoidal output voltage: a modern inverter with modulation control of the pulse width (PWM) generates a sinusoidal output with minimum distortion, allowing power to be supplied to sensitive apparatus.
- High input power factor and low distortion sinusoidal of input current: the high frequency rectifier with IGBT's has a power factor corrector (PFC) which allows the UPS consumes power with a power factor near to unity and with a low distortion sinusoidal of input current, no matter what type of connected load to the equipment.
- Microprocessor control: All the power conversions are controlled by totally digital signal. Excellent performance and reliability are realized together with all kinds of protection functions.
- Instantaneous transition from normal to battery mode operation and vice versa: as this is a double conversion model, there is no failure in the output voltage in transitions between mains and battery.
- High input voltage range: The rectifier works at mains of low voltages at full load, which prevents energy from being extracted from the battery even at these voltages.
- High efficiency: this UPS range has a high efficiency up to 92%.
- Protected against overloads and short-circuits: ZIGOR's UPSs are fitted with protection circuits that prevent the device from being damaged by short-circuit or excess load.
- Front control panel: in the front of UPS there are LED indicators, a LCD display and a keypad which indicate the operation mode, mimic diagram, warning and failure information, and allow browsing through the display to monitor UPS data and necessary settings.
- Monitoring software: included RS232 and USB type connections which, by means of software, allows you to save files, run programmes, turn off the PC, etc., as well as monitoring in real-time the status of the UPS.
- Self-Battery and UPS test: also is included a function that performs a battery and UPS test in order to check status of them.
- Battery test: this series has an option that performs a battery test in order to check the battery status.
- 3-level intelligent charger: UPS of this series has an intelligent charger of three optimized battery charge levels to enlarge the lifetime of the batteries.

- Cold-Start function: this function allows turning on the UPS directly from the batteries when the grid is not available.
- Re-Start function: thanks to this feature, in case of mains failure and UPS shutdown due to flat batteries, the UPS will start again automatically when mains is recovered even long time has passed after power failure.
- Programmable outlets: UPS have outlets for non-essential loads which in battery mode will be disconnected before outlets for priority loads, for the purpose of extending the autonomy of the UPS.

### 2.3 Optional characteristics

- Intelligent slot: this UPS is fitted with one expansion port to which optionally Ethernet (SNMP protocol) or dry contact cards can be assembled. Any of these modules can be used simultaneously with the RS232 and USB ports.
- ECO mode: these models can be configured in ECO mode in which they operate in “off-line” mode, providing greater energy efficiency while losing the advantages of “on-line” operation.
- Frequency converter: these models can be configured in order to operate with frequency converters, providing 60Hz with 50Hz input and vice versa.

### 2.4 Construction of the unit

This device is built in steel frames with removable panels.

On the front of the UPS there is a liquid crystal display and a series of luminous indicators and buttons that allow the operator to monitor the UPS.

All the electrical connections and access to the protections in UPS can be found at the rear of the UPS.

The UPS is cooled by means of forced ventilation. The air is introduced and expelled through vents placed on the front, rear and sides of the UPS. These areas must be free of any object so that the air can circulate freely inside and outside the UPS.

## 3 INSTALLATION

### 3.1 Reception of material

Remove the UPS from the packaging and carry out a visual examination in order to detect any damage that might have occurred during transport. Notify the seller about any damage.

List and check all the items indicated on the delivery note. Check that the material delivered corresponds with the delivery note. Check the manufacturer's identification plates located on the rear or side of the UPS.

*No claims will be accepted if, 24 hours following the delivery of the goods, no notification of reception of material in bad conditions has been received and if this circumstance is not notified to the forwarding agent at the time of delivery.*



#### WARNING

*The UPS contains lead batteries that are charged when they leave the factory.*

*They can be stored for up to two years provided that they are recharged on a periodic basis, at least every six months, during storage.*

*Should these recommendations not be observed, the battery warranty will be rendered null and void.*

### 3.2 Installation conditions

The place chosen for the installation must meet the following characteristics:

- Protection against dust.
- Protection against excessive humidity and heat sources.
- Protection against atmospheric agents.
- Avoid exposure to corrosive gases and agents.
- Temperature of operating atmosphere between +20° C and +25° C.
- Easy connections.
- Proximity to magnetic fields and high-power lamps must be avoided.
- Prevent the UPS being exposed to the sun.
- Do not obstruct the vents as this would prevent the correct dissipation of the heat produced by the UPS. The minimum distance from the ventilation grills to walls or other obstacles must be 300mm.

### 3.3 Connections

All electrical connections of the UPS are made from the rear side of the device. Below is shown the rear panel view of all models.

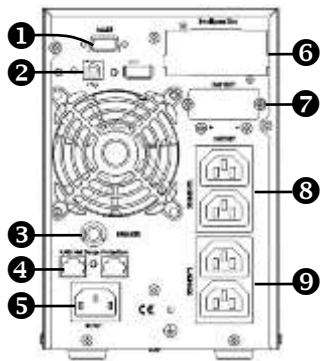

ZGR TOWER PRO 1KVA  
ZGR TOWER PRO 1KVA LBT

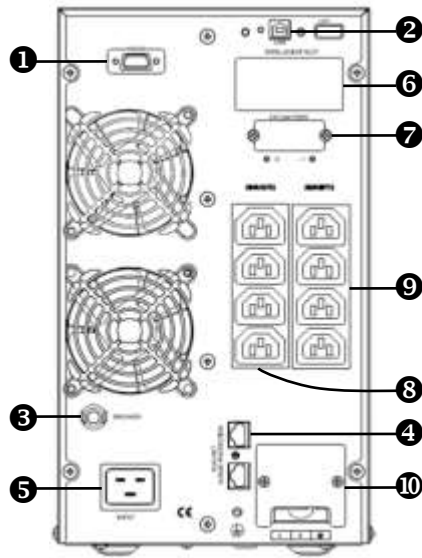

ZGR TOWER PRO 2KVA  
ZGR TOWER PRO 2KVA LBT

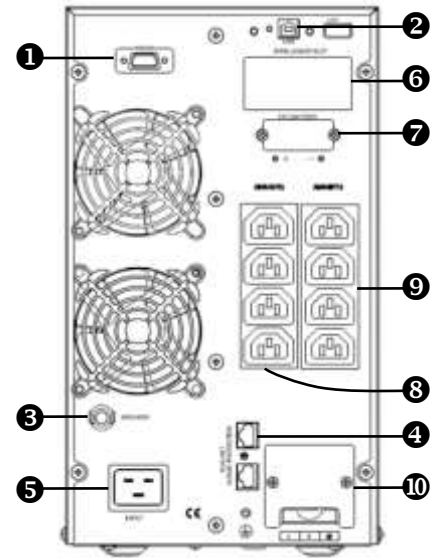

ZGR TOWER PRO 3KVA  
ZGR TOWER PRO 3KVA LBT

1. RS232 communication port
2. USB communication port
3. Input circuit breaker
4. RJ45 overvoltage protection
5. Input socket

6. Expansion port
7. External battery connector
8. Non-essential outlets (SEGMENT1)
9. Priority outlets (SEGMENT2)
10. Output terminals
11. EPO connection (near to USB)

Fig. 3-1 Rear panels of ZGR TOWER PRO 1-3KVA models

The nominal voltage for UPS input and outputs is 200/208/220/230/240 Vac, 50/60 Hz.

Connecting cables, both for UPS input and output, must be 3-wire connections (phase + neutral + ground). In all cases, connections are made by means of IEC type connectors, or terminals, depending on model.

Take the following steps into consideration in order to make the connections of the equipment:

1. **Connect the input cable to "INPUT" socket of the rear of the equipment, and the other end of the cable to the appropriate mains outlet. The power cord is supplied in the UPS package.**

At the rear of the unit there is access to an input circuit breaker.

2. Connect the devices (loads) to the UPS outputs:

- For socket-type outputs, simply connect devices to the IEC sockets.
- For terminal-type outputs (if available), follow below steps:
  - Remove the small cover of the output terminals and connect the wires.
  - Upon completion of the wiring, check whether the wires are securely affixed.
  - Put the small cover back to the rear panel.



**WARNING**

*Should the number of UPS outlets are not enough, a power strip with an extension lead can be used. In order to avoid power interruptions due to error, we advise you not to use adapters with a built-in switch.*



**WARNING**

*If load is connected to output terminals, it is recommendable to use 2.5mm<sup>2</sup> or AWG14 cable.*

### 3.3.1 External battery connections (only “LBT” long backup time models)

In “LBT” models, the UPS must be connected to the battery cabinets. According to the required backup time, these cabinets can be TOWER PRO type or A type.

Follow instructions below according the type of cabinet.

#### 3.3.1.1 TOWER PRO type cabinet

The appearance and the design of these cabinets are specific for ZGR TOWER PRO 1-3 KVA UPS range. Inside them, 7 or 9 Ah and 12V battery branches are pre-installed at the factory to facilitate their installation.

Simply connect the UPS to the battery cabinet using the supplied cable. The connectors of this cable are prepared to allow insertion only in the correct position.

The connectors are prepared in such a way that they can only be inserted in the correct position.

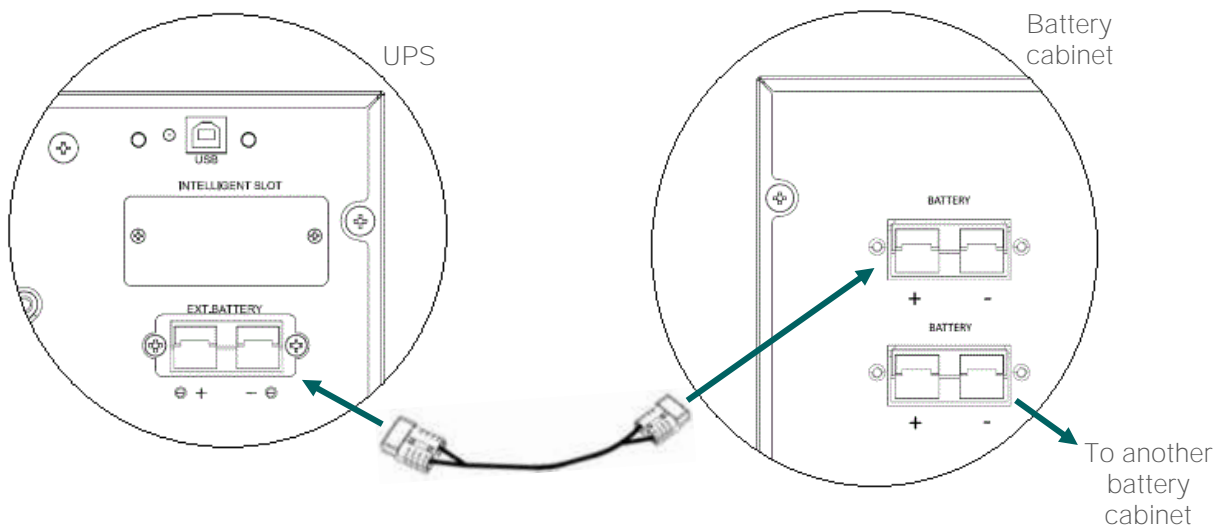

Fig. 3-2 Battery connection with TOWER PRO type cabinets

If more autonomy is required than initially acquired, additional cabinets of this type can be added.

In case of internal battery models, only one additional cabinet with one battery string can be added.

#### 3.3.1.2 A type cabinet

When TOWER PRO type cabinets are not enough for the acquired backup time because higher capacity battery is required, the use of A type cabinets is necessary. These cabinets are designed to house different type and quantity of batteries, so that the installation must be done in the final location.

Follow carefully the steps below:

- Make sure that the UPS is completely switched off and disconnected from the mains supply before adding the batteries.
- Check the voltage of each battery.
- Assemble the battery cabinet(s) in accordance with the instructions included with the cabinet. Remember to leave a minimum distance of 500mm between a lateral panel of each battery cabin and the obstacles there may be around the battery cabinet. In this way, assembly and maintenance of the batteries are easier.
- Install the breaker in accordance with the instructions included with the battery cabinet and check it is open.
- Place and wire the batteries distributed over the cabinet divisions in accordance with the included battery assemble drawing.
- Connect the battery cabinet(s) to the corresponding UPS terminals.

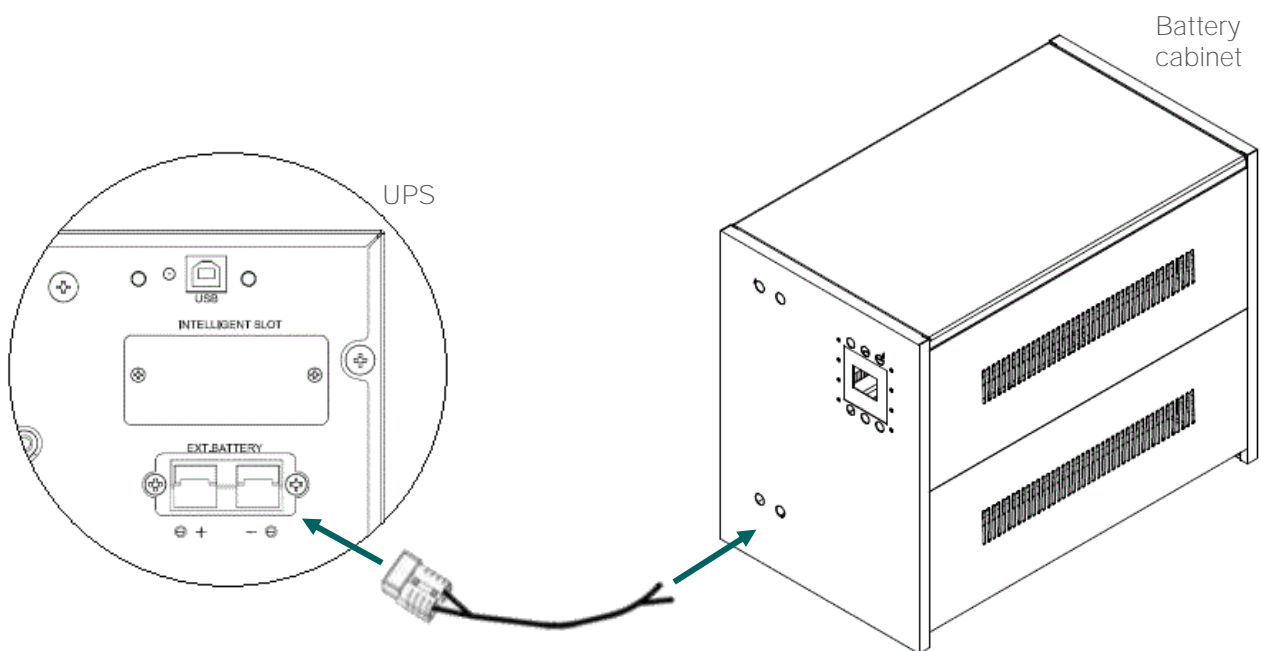

Fig. 3-3 Battery connection example with A type cabinets

- Check total voltage and polarity of each battery string is correct.



**WARNING**

*Be careful to check battery connector voltage and battery pack voltage. It must be the same.*

*Each UPS has its own optimized design battery bus voltage.*

*Check printed voltage under connector on rear panel before connecting battery pack.*

In case of doubt, contact our customer service (sac@zigor.com).



WARNING

*Battery type, aging or manufacturer should not be mixed. If you want to increase UPS autonomy or replace batteries, contact ZIGOR customer service and follow our recommendations.*



WARNING

*Batteries must be installed exclusively by personnel authorised by ZIGOR. ZIGOR takes no responsibility for damage caused by external batteries installed by personnel not authorised by ZIGOR.*

*Follow these steps with care:*

- *The voltage of battery terminals is dangerous even when the UPS is not in operation. Access to the interior of the battery cabinet shall be restricted to trained personnel.*
- *A short-circuit on the battery terminals (or of one of its elements) before the breaker or fuse is EXTREMELY DANGEROUS as the current will be limited only by the internal resistance of the battery and the wiring. These extremely high currents can cause the battery to explode, melt cables, tools and other metal objects.*
- *Do not attempt to open the batteries. These contain electrolyte, which can cause burns to eyes and skin.*
- *Do not wear rings, bracelets, watches, etc., as these could cause short-circuits or electric shocks.*
- *Use insulated tools.*
- *Wear gloves, insulated protective shoe wear and safety goggles.*
- *Discharge body static electricity before making connections.*
- *Do not place tools on the batteries.*
- *Do not place batteries near fire or high heat emitters.*
- *Do not smoke.*

## 4 OPERATION OF ZGR TOWER PRO 1 – 3 KVA

### 4.1 Control panel

The control panel is placed on the front of the UPS. It consists of the following items:

- LED indicators: there are four LEDs to show the UPS working status.
- LCD display: indicates the status of the unit and information about battery, load, input, output, alarms or backup times.
- Buttons: there are four buttons to control the operation of the UPS.

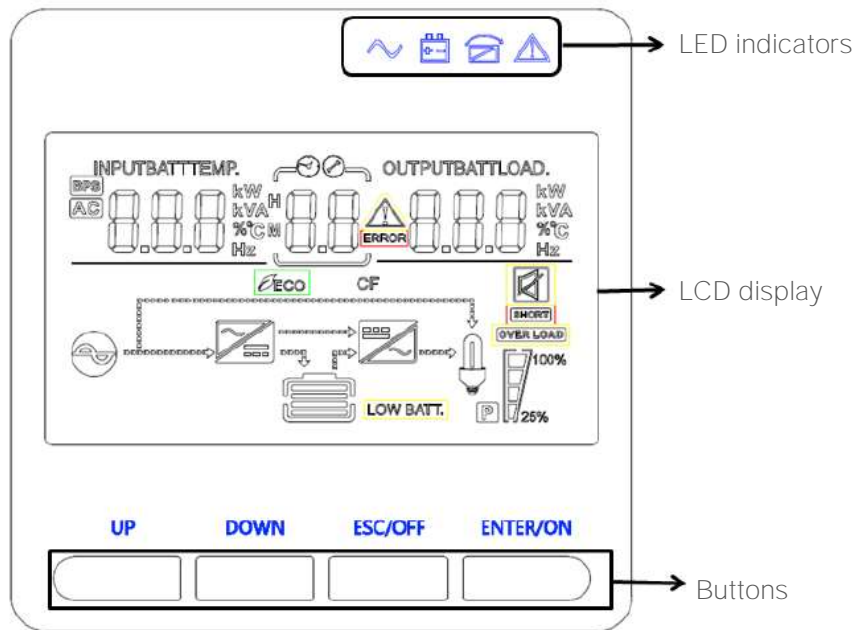

Fig. 4-1 UPS control panel

#### 4.1.1 LED indicators

In the below table is defined the meaning of the LED indicators when illuminated:

LED	COLOUR	DESCRIPTION
	Red	UPS has an alarm (warning or fault).
	Yellow	UPS is in Bypass mode or ECO mode.
	Yellow	UPS is in Battery mode.
	Green	Inverter is working.

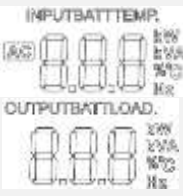



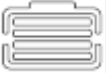





Table 4-1 LED indicators meaning

NOTE: On different operation modes, these indicators will indicate differently.



## 4.1.2 Display information

In the below table is shown and explained all the elements that can appear in the display:

SYMBOL	DESCRIPTION
UPS general information	
	Indicates input, output, battery and UPS general information. This section is explained in the Table 4-3.
Backup time, alarm and setting information	
	Indicates the remaining backup time when UPS is in battery mode. H: hours, M: minutes
	Indicates warning code (warning symbol blinking).
	Indicates fault code (error symbol lit).
	Indicates parameter number in setting menu.
Battery information	
	Indicates the battery capacity: 0-24 %, 25-49 %, 50-74 % y 75-100 %.
<b>LOW BATT.</b>	Indicates low battery level.
Load information	
	Indicates load level: 0-24 %, 25-50 %, 50-74 % y 75-100 %.
<b>OVER LOAD</b>	Indicates overload.
<b>SHORT</b>	Indicates the load or the UPS output is short circuited.
Mute operation	
	Indicates that the UPS alarm is muted.
UPS status information	
	Indicates UPS is connected to the mains.
	Indicates rectifier is working.
	Indicates inverter is working.





	Indicates there is voltage at UPS output.
	Indicates UPS is in ECO mode.
	Indicates UPS is in frequency converter mode.
	Indicates not essential outputs are active.

Table 4-2 Display information

Pressing “UP” or “DOWN” buttons, the information shown in “UPS general information” section is switched sequentially. The available screens are as below:







SCREEN	DESCRIPTION	DISPLAYED CONTENT
01	Input and output voltage	
02	Input and output voltage	
03	Battery voltage and capacity	
04	Internal temperature	
05	Power demanded by the load	
06	Firmware version	
07	UPS model S: internal battery model H: LBT model	

Table 4-3 Available screens in LCD display

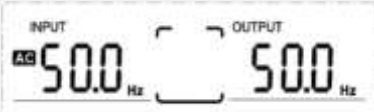
#### 4.1.3 Alarm list

When there is any alarm, a code besides  symbol blinking in case of warning or beside **ERROR** symbol in case of fault are shown in the “alarm information” section of the LCD display. The table below describes the possible alarm codes.

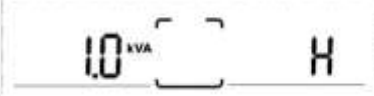





















CODE	ALARM	BUZZER	LED INDICATOR
1	Rectifier Fault	Beep continuously	 lit
2	Inverter fault (Including Inverter bridge is shorted)	Beep continuously	 lit
9	Fan fault	Beep continuously	 lit
12	Self-test fault	Beep continuously	 lit
13	Battery Charger fault	Beep continuously	 lit
15	DC Bus over voltage	Beep continuously	 lit
16	DC Bus under voltage	Beep continuously	 lit
17	DC bus unbalance	Beep continuously	 lit
18	Soft start failed	Beep continuously	 lit
19	UPS Inner Over Temperature	Twice per second	 lit
20	Heatsink Over Temperature	Twice per second	 lit
26	Battery over voltage	Once per second	 blinking
27	Mains Input reverse	Once per second	 blinking
28	Bypass Input reverse	Once per second	 blinking
29	Output Short-circuit	Once per second	 blinking
30	Input current limit	Once per second	 blinking
31	Bypass over current	Once per second	 blinking
32	Overload	Once per second	 or  blinking
33	No battery	Once per second	 blinking
34	Battery under voltage	Once per second	 blinking
35	Battery low pre-warning	Once per second	 blinking
36	Over load time out	Once per 2 seconds	 blinking
37	DC component over limit	Once per 2 seconds	 blinking
39	Mains volt. Abnormal/Out of range	Once per 2 seconds	 lit
40	Mains freq. abnormal/Out of range	Once per 2 seconds	 lit
41	Bypass Not Available		 blinking
42	Bypass unable to trace		 blinking
43	Inverter ON invalid		
44	UPS in bypass mode for a long time		

Table 4-4 LCD alarm list

#### 4.1.4 Pushbutton functions

Buttons are located in the front in the UPS under the display, as you can see in Fig. 4-1.

In the table below is defined the meaning and the button functions:

BUTTON	FUNCTION
ENTER/ON	<ul style="list-style-type: none"> <li>• <i>Start the UPS:</i> Press and hold this button for at least 2 seconds to turn on the UPS.</li> <li>• <i>Carry out battery test:</i> Press and hold this button for 2 seconds to carry out a battery test while in normal mode or frequency converter mode.</li> <li>• <i>Mute the alarm:</i> When the UPS is on battery mode, press and hold this button for at least 2 seconds to <b>disable or enable the alarm system</b>. But it's not applied to the situations in case of warnings or faults.</li> <li>• <i>Setting menu:</i> Press this button to confirm current setting.</li> </ul>
ESC/OFF	<ul style="list-style-type: none"> <li>• <i>Stop the UPS:</i> Press and hold this button at least 2 seconds to turn off the UPS. Factory-made, it will transfer to bypass mode. If transferring to standby mode is desired, set parameter 10 in setting menu.</li> <li>• <i>Setting menu:</i> Press this button to exit setting menu without saving changes or to cancel a setting.</li> </ul>
UP	<ul style="list-style-type: none"> <li>• <i>Up button:</i> Press this button to <b>go back to previous screen of "UPS general information" section</b>.</li> <li>• <i>Setting menu:</i> Press this button to go back to previous parameter or to change the value of the parameter.</li> </ul>
DOWN	<ul style="list-style-type: none"> <li>• <i>Down button:</i> Press this button to advance to next <b>screen of "UPS general information" section</b>.</li> <li>• <i>Setting menu:</i> Press this button to advance to next parameter or to change the value of the parameter.</li> </ul>
UP + DOWN	<ul style="list-style-type: none"> <li>• <i>Setting menu:</i> Press and hold both buttons at least 5 seconds to access setting menu.</li> </ul>

Table 4-5 Pushbutton functions

#### 4.1.5 UPS setting menu

Certain UPS parameters can be configured in the setting menu.

To enter this menu and navigate through it, follow these steps:

- After the UPS is powered, **press buttons "UP" and "DOWN"** buttons for at least 5 seconds to enter setting menu.
- Use "UP" or "DOWN" buttons to choose the parameter to be set.
- Press "ENTER/ON" button to modify the selected parameter. The value to be set will start flashing.
- Use "UP" or "DOWN" buttons to choose the desired value.
- Press "ENTER/ON" button to confirm the value, or press "ESC/OFF" button to cancel the setting.
- To exit the menu without saving changes, press "ESC / OFF" button or wait 30 seconds.

To exit the menu saving the changes, press "DOWN" button until you exit to "UPS general information" screen.



Set only the desired parameters. It is recommended not to perform settings without knowledge as it can be dangerous or cause damage of the UPS or the loads.

Battery must be connected to the UPS so that the setting is permanently saved.

In case of doubt, contact our customer service (sac@zigor.com).

The table below describes the parameters that can be set.

PARAMETER	SETTINGS	DISPLAYED CONTENT
01	Operating mode setting Possible values are the following: - NOR: normal mode (default) - CF: frequency converter mode - ECO: ECO mode	
02	Nominal output voltage setting Possible values are 200, 208, 220, 230 or 240 (default 230 V)	
03	Output frequency setting Possible values are 50 or 60 (default 50 Hz)	
04	Battery capacity setting Value range is 1-200 Ah.	
05	Non-essential output disconnection setting To configure the disconnection of loads connected to non-essential outputs (SEGMENT1). Possible values are 1.75, 1.84 or 1.92 (default 1.75 V). Indicates voltage per battery cell.	
06	End of discharge setting To configure the disconnection of loads connected to priority outputs (SEGMENT2). Possible values are 1.60, 1.75 or 1.80 (default 1.75 V). Indicates voltage per battery cell.	
07	Bypass voltage upper limit setting Value range is 230-264 (default 264 V).	
08	Bypass voltage lower limit setting Value range is 176-220 (default 176 V).	
09	Buzzer setting Possible values are ON or OFF (default ON).	

10	Bypass enable/disable setting To set the operating mode when UPS is stopped. Possible values are the following: - ON: transfers to bypass mode (default) - OFF: transfers to standby mode	
----	---	--

Table 4-6 UPS settings

## 4.2 Operation modes

Depending on external or internal conditions, the ZGR TOWER PRO 1-3 KVA has the following operating modes.

### 4.2.1 Normal mode (ONLINE)

UPS supplies all connected loads with continuous pure sine wave voltage with stable frequency and amplitude during normal operation mode.

Rectifier and inverter units run continuously. Load is supplied with a stable voltage generated by the inverter. Inverter and bypass voltages are synchronized. Batteries are constantly kept at a Floating or Boost charge voltage.

In this operation mode, control panel shows the current status as below:

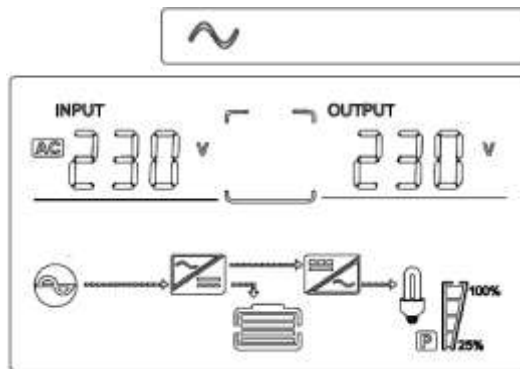

Fig. 4-2 Control panel in normal mode

### 4.2.2 Battery mode

If the electricity mains supply is subject to any disturbance not tolerated by the UPS, rectifier unit does not run and the inverter unit, which obtains power from the battery, continues to supply the load. There is no interruption in power to the load upon failure. After mains returns to normal conditions, UPS will switch to normal operation mode automatically without the necessity of user intervention.

The batteries have a limited autonomy. Should the aforementioned autonomy be exceeded in battery mode, the load will be left without electricity until the mains electricity returns to its established parameters.

In this operation mode, control panel shows the current status as below:

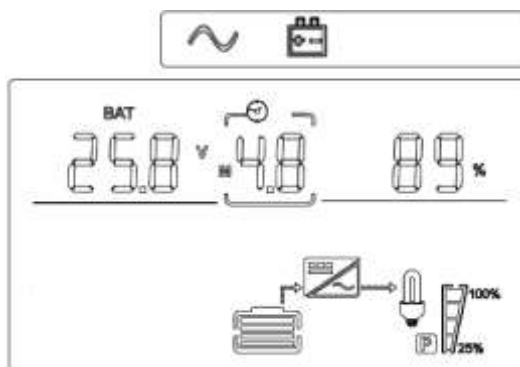

Fig. 4-3 Control panel in battery mode

### 4.2.3 Bypass mode

During the following conditions, the static bypass switch will perform a transfer of the load from the inverter to the bypass source, with no interruption in power to the load:

- UPS is powered on or stopped (configuration by default)
- overload capacity of the equipment is exceeded
- UPS has a serious failure for any reason
- it is transferred manually

In this mode the loads are supplied directly from mains through static bypass circuit, therefore loads are not protected against any disturbance in the mains. Inverter and rectifier units do not run, only charge the battery.

In this operation mode, control panel shows the current status as below:

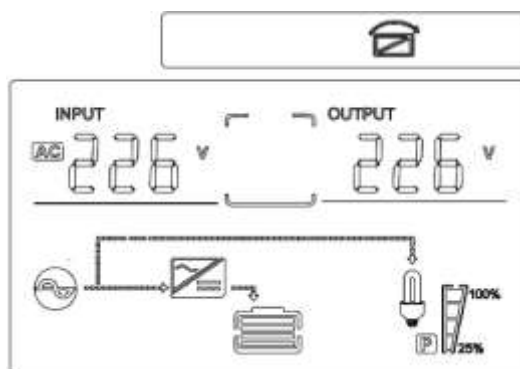

Fig. 4-4 Control panel in bypass mode

### 4.2.4 Standby mode

UPS is on this operation mode when the equipment is on bypass mode and bypass voltage and/or frequency is out of limits. Moreover, making a configuration in the setting menu, the equipment also can be in this operation mode when is powered on or stopped.

In this operation mode, rectifier, inverter and bypass unit do not run, therefore the loads are not supplied, and only the battery is charged.

If there are no alarms and mains supply is correct, ON button can be pressed to start ONLINE mode.

In this operation mode, control panel shows the current status as below:

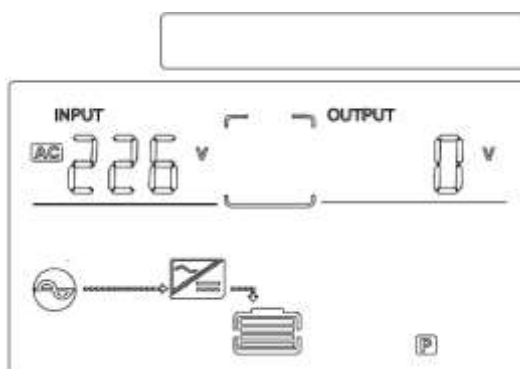

Fig. 4-5 Control panel in standby mode

### 4.2.5 ECO mode

It is possible to configure in the setting menu the activation or deactivation of the ECO mode. If the ECO mode is enabled and the input range voltage is correct, the UPS will provide directly the mains voltage to the output in order to save energy but losing the advantages of Online double conversion. In this operation mode, the charger is also active charging the battery, and the rectifier and inverter are active waiting for, so the equipment will backup before mains failure.

In this operation mode, control panel shows the current status as below:

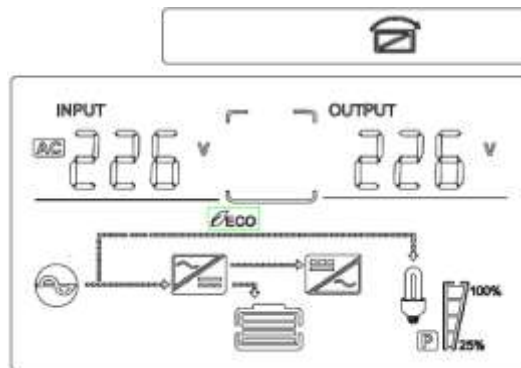

Fig. 4-6 Control panel in ECO mode

#### 4.2.6 Frequency converter mode

When input frequency is within 40 Hz to 70 Hz, the UPS can be set at a constant output frequency, 50 Hz or 60 Hz. This mode is configurable in setting menu. The UPS will still charge battery under this mode, but bypass is disabled.

In this operation mode, control panel shows the current status as below:

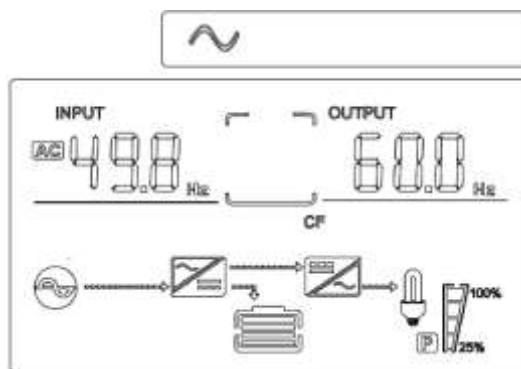

Fig. 4-7 Control panel in frequency converter mode

## 4.3 Operation procedures

### 4.3.1 Before Start-up

- Check that all the loads are off.
- Check that load connected to the UPS does not exceed the nominal value. It is not recommended to connect high-consumption devices or with high start-up spikes such as laser printers or motors to the UPS.
- Check the installation and load cables to ensure that there are no short-circuits or non insulated parts within reach of the user.
- Check that the outlet to which the UPS is to be connected complies with the power requirements and that it is in good condition.
- When installing the equipment, it should have ensured that the sum of the leakage current of the UPS and the connected devices does not exceed 30mA.
- It is recommended to put the critical loads in SEGMENT2 outlets and the non-essential loads in SEGMENT1 outlets.

### 4.3.2 First Start-up

Once the steps outlined in the previous section have been completed, you can start up the unit for the first time.



- In LBT models, set the battery breaker/s at “ON” position.
- As soon as we connect the UPS to the mains, the display will light and LED indicators will turn on and off sequentially. After a few seconds, the equipment will transfer to bypass mode (configuration by default).

*If UPS shows alarm 27/28 on LCD screen, go to User Manual section 6 Troubleshooting.*

- **Press the “ENTER/ON” button of the control panel for 3 seconds**, then the UPS will start to turn on until transferring to normal mode.
- Wait for 20 seconds for the inverter to stabilise and begin to turn on the loads in order, starting with high consumption loads and leaving lower consumption loads to last. Bear in mind that some loads have a very high consumption spike during start-up and may cause the UPS protection. For this reason it is recommendable to start up this kind of loads first.

If the UPS is overload, the buzzer will beep every second. Please remove some loads immediately. It is recommended to have the total loads connected to the UPS less than 80% of its nominal power capacity to extend the life of the system.

Remember that when stored, the battery loses its charge over a period of time. For this reason after the first start-up it is recommendable to leave the battery to charge for at least 5 hours.

#### 4.3.3 Cold-Start: Start-up without mains

If you wish to turn on the UPS without being connected to the electricity grid, that is, from the battery, proceed as follows:

- **Press the “ENTER/ON” button from control panel for 3 seconds**, then the UPS will start to turn on until transferring to battery mode. The display will show the backup time.

#### 4.3.4 Regular starts and stops

If you plan to start and stop the UPS on a regular basis, it is recommendable to follow this procedure:

- For stopping the UPS:
  - It is recommended to turn off all the loads.
  - Leave the UPS to operate without load for about 20 seconds so that the heat can be ventilated.
  - **After this, press the “ESC/OFF” button on the UPS panel for at least 3 seconds.**
  - Bear in mind the equipment will transfer to bypass mode, the UPS will charge the battery or will maintain the charge of the battery, and supplying voltage in the output but not protected against any disturbance (configuration by default).
- For starting the UPS:
  - **Press the “ENTER/ON” button of the control panel for 3 seconds**, then the UPS will start to turn on until transferring to normal mode.
  - Wait for 20 seconds for the inverter to stabilise and begin to turn on the loads in order, starting with high consumption loads and leaving lower consumption loads to last.

#### 4.3.5 Switching off for a long period

If the equipment is to be switched off for a long period of time, it is recommendable to ensure that the battery is fully charged. If the UPS has not switched to battery mode over the last 4 hours, the battery will be fully charged. If this is not the case, leave it to charge for at least 4 hours.

If the UPS is to be disconnected for more than one month, the battery must be disconnected in order to prevent residual consumption from completely discharging it, rendering it permanently unusable.

Important: Temperature affects the service life of the battery. The optimum temperature is 20°C. An increase of 10°C can reduce its service life by half.

Turn off the UPS in accordance with the following procedure:

- First turn off all the loads.
- Leave the UPS to operate without load for about 20 seconds so that the heat can be ventilated.
- **After this, press the “ESC/OFF” button for at least 3 seconds.** The UPS will transfer to bypass mode.
- Switch off the input cable from the mains.

In order to start up the unit following this shutdown sequence, follow the indications in section 4.3.2.

#### 4.3.6 Battery mode operation

Take into account the following considerations when UPS is in battery mode.

- When the UPS is in battery mode, the buzzer will beep according to different battery capacity. If the battery capacity is more than 25%, the buzzer will beep once every 4 seconds; If the battery voltage drops to the low battery level, the buzzer will beep quickly (once every sec) to remind users that the battery is at low level and the UPS will shut down automatically soon. Users could switch off some non-critical loads to prolong the backup time. If there is no more load to be switched off at that time, you have to shut down all loads as soon as possible to protect the devices or save data. Otherwise, there is a risk of data loss or load failure.
- Loads connected to non-essential outlets are disconnected earlier to extend the backup time of loads connected to priority outlets (cut-off voltage of these non-essential outlets can be adjust in setting menu).
- **In battery mode, if buzzer sound annoys, users can press the “ENTER/ON” button to disable the buzzer.**
- The backup time may vary depending on the battery capacity, the environment temperature and the load type.

#### 4.3.7 Battery test

If you need to check the battery status when the UPS is running in normal mode or frequency converter mode, **you could press the “ENTER/ON” button for 2 seconds** to let the UPS do battery test.

User also can set battery self-test through monitoring software. (Computer and monitor software must be active in order to work properly)

If the UPS is at battery test, the control panel will be as below (LED indicators turn on and off sequentially):

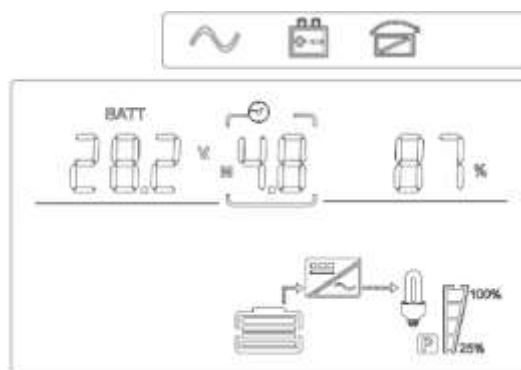



Fig. 4-8 Control panel carrying out a battery test

#### 4.3.8 Mute the buzzer

To mute the buzzer when the equipment is on battery mode, please press the “ENTER/ON” button for at least 2 seconds. If you press it again after the buzzer is muted, the buzzer will beep again.

The buzzer cannot be muted in this way if the UPS is in low battery or some other warning or fault exists. To do this, setting menu should be used.

#### 4.3.9 Operation in warning status

When icon  appears in the display flashing and the buzzer sounds, it means that there are some problems for UPS operation. Users can get the fault code from LCD panel. Please check the trouble shooting table in section 6 for details.

#### 4.3.10 Operation in fault status

When icon  appears in the display and the buzzer sounds, it means that there is a serious fault in the UPS. Users can get the fault code from display panel. Please check the trouble shooting table in section 6 for details.



*Don't try to turn on the UPS again before solving the problems. If the problems can't be fixed, please contact our customer service ([sac@zigor.com](mailto:sac@zigor.com)).*

*For emergency case, please cut off the connection from utility immediately to avoid more risk or danger.*

## 5 COMMUNICATIONS

ZGR TOWER PRO 1-3KVA series has several communication ports to allow monitor and program some customer parameters; such as UPS status (variables, history data and alarms) and set computer and UPS shutdown automatically under mains fault.

Also, it includes an Intelligent slot for optional advanced communication card (SNMP/Modbus) or dry contact alarm notification (relays).

Communication ports are on rear panel.



Fig. 5-1 Communication ports

Notes: Simultaneous communication through UPS and RS232 port is not allowed.

### 5.1 USB port

Connect provided USB cable to UPS USB port and the other side to computer USB port.

Install UPSilon 2000 software in your computer to monitor UPS status. To obtain this software, follow steps in the instruction card included with the manual. You also can obtain it from our website [www.zigor.com](http://www.zigor.com) or asking for our Customer Service ([sac@zigor.com](mailto:sac@zigor.com))

USB connector on UPS side is type B female and pinout is defined as image below.

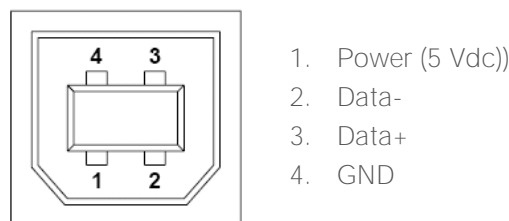

Fig. 5-2 USB communication port

### 5.2 RS232 port

Connect RS232 cable (not included) to UPS and the other side to computer port RS232.

As well as with the USB port, UPSilon 2000 software must be installed. The RS232 provides the same options than USB port.

RS232 connector on UPS side is female DB9 type and pinout is defined as image below.



Fig. 5-3 RS232 communication port

### 5.3 Intelligent slot

The UPS is equipped with a slot that is designed optionally for either SNMP/Modbus or dry contact cards. Only 1 slot is available on this UPS family, so you need to determine what kind of card to install.

This intelligent slot is Plug&Play, so once inserted, communication will be established without the need for any adjustment on the UPS display.



Fig. 5-4 SNMP/Modbus card view



Fig. 5-5 SNMPview software image

#### 5.3.1 TCP-IP communications cards (optional)

The SNMP/Modbus communications card has an RJ45 female connector to allow advanced UPS management remotely via an Ethernet network.

It also has a mini-USB connection to optionally connect a concentrator (HUB) of environmental sensors with sound alarm. (Temperature, Humidity, Flood,...)

#### *IMPORTANT: INTERNET SECURITY*

*On newer models, these cards include several advanced security protocols such as HTTPS, SSL, TLS, SNMP v3.*

*If you are going to expose this card to the internet, you must ensure that you have other protection/security systems that prevent vulnerabilities from being traced, and in any case disable the functionalities that you do not wish to use.*

*ZIGOR cannot be held responsible for damage caused by cyber-attacks if exposed directly to the internet.*

The most common UPS monitoring protocols are included; SNMP and Modbus TCP/IP.

This card, autonomously and without the need for additional software, allows notifications to be sent via e-mail of different events that occur in the UPS. For example, when there is a loss of main AC power supply, an overload due to a short circuit at the output, a defect in the device itself, and others. Even send daily reports of important events.

The most advanced model of this card also allows notifications via TELEGRAM, SKYPE, LINE.

It includes BACnet protocol support, GigaLAN connectivity (1000Mbit), more notifications and selectable recipients and up to 13 languages.

All functionalities can be managed via an integrated web server that can be accessed from any web browser (Safari, Edge, Chrome, Firefox, Edge and others).

A proprietary software package (NetAgent) compatible with various Operating Systems (Windows, MAC, Linux, VMware) is also available to monitor / manage one or multiple UPS simultaneously.

(1) NetAgent updates are limited and there may be incompatibilities on newer OS.

**IMPORTANT: ELECTRONIC SECURITY**

*This card only allows monitoring and modification of certain parameters that do not affect the electronic operation of the UPS.*

*It is not possible to modify the most important electronic operating settings defined by the display. (voltage, frequency, type and capacity of battery)*

*To avoid damaging the UPS, these settings must only be made manually and in person by authorised and experienced personnel.*

5.3.2 Dry-contact relay card (optional)

Dry contact card has a terminal connector and could be used to monitor UPS status in real time through relay contacts.

Consists of 6 non-programmable contacts with both terminals. Norm.Open (NO) and Norm.Closed (NC)

The programmed functions are as follows:

PIN	UPS ONLINE (NO ALARMS)	Function	EXAMPLE ( MAINS FAIL )
1	COM	Common terminal	
1-2		Inverter mode. ONLINE active	
1-3		AC mains lost (UPS in battery mode)	
1-4			
1-5		Low battery	
1-6			
1-7		Any alarm active	
1-8			
1-9		Bypass active (unprotected load)	
1-10			
1-11		UPS internal fail	
1-12			

Tabla 5-1 Dry-contact terminals function



Fig. 5-6 Dry-contact card image

For more information or support, please consult its respective manual or contact our Customer Service Support ([sac@zigor.com](mailto:sac@zigor.com)) .

## 5.4 UPS remote access

If you have purchased a communications card:

- Connect the Ethernet cable to establish communication within your LAN.
  - Locate and run the NETILITY software (Fig. 5-7)
  - It will search your LAN for any compatible communications cards.
  - If there are multiple cards detected, you will see a list of all of them.
  - By default, DHCP service is enabled for automatic IP assignment.
- Once detected, you will be able to view the IP, MAC address, serial number and firmware version.
- Select the "Launch Web" icon and you will access the card management webserver.



Fig. 5-7 Netility software main screen

### 5.4.1 IP manual assignment

Using the "Network settings" icon, you can manually assign the IP address to your card, modify the HTTP/HTTPS/Telnet/SSH management ports and assign a main access password to the webserver.

#### *PASSWORD RESET*

*To reset and disable the password you must remove the card and on bottom PCB will be a model label, then you will see the reset password (the password is unique and non-transferable for each card).*

*Access the IP of the card <http://xxx.xxx.xxx.xxx/password.cgi> and on the screen that will appear, as user ID: admin and as password: (see label password).*

*If you lose or do not have this label it will not be possible to reset the card and you will have to buy a new one.*

### 5.4.2 NetAgent webserver main screen

When accessing the webserver through the Netility application or directly if you already know the IP address, you will find a main screen similar to the one shown in (Fig. 5-8).



Fig. 5-8 NetAgent main webserver screen

- In the "Configuration" menu you can find the main settings of the card (Fig. 5-9).



Fig. 5-9 Configuration menu

*Note: The available options may differ depending on the card model purchased or may change without prior notice.*

For more information or support, please consult its respective manual or contact our Customer Service Support ([sac@zigor.com](mailto:sac@zigor.com))



## 6 TROUBLESHOOTING

### 6.1 Malfunctions of ZGR TOWER PRO 1 – 3 KVA

ZIGOR recommends that, in case of any anomaly, strange noise or supposed malfunction, the equipment should be shut down and ZIGOR customer service should be contacted.

The ZGR TOWER PRO 1 – 3 KVA system has a specific section in the display which shows the alarm code that is generating the fault. The description of each alarm is described in section 4.1.3.

The following table summarizes different anomalous conditions and their possible solution (Table 6-1).







SYMPTOMS	POSSIBLE CAUSES	SOLUTIONS
No indication and alarm even though the mains is normal.	The AC input power is not connected well.	Check if input power cord firmly connected to the mains.
	The AC input is connected to the UPS output.	Plug AC input power cord to AC input correctly.
Alarm code is shown as “33” and  LED blinking.	The external or internal battery is not connected.	Check if all batteries are well connected.
Alarm code is shown as “26” and  LED blinking.	Battery voltage is too high or the charger is fault.	Contact ZIGOR.
Alarm code is shown as “34” and  LED blinking	Battery voltage is too low or the charger is fault.	Contact ZIGOR.
Alarm code is shown as “32” and  or  LED blinking.	UPS is overload	Remove excess loads from UPS output.
Alarm code is shown as “29” and  LED light.	The UPS shut down automatically because short circuit occurs on the UPS output.	Check output wiring and if connected devices are in short circuit status.
Alarm code is shown as “9” and  LED light.	Fan fault.	FAN damaged or blocked. Contact ZIGOR.
Alarm code is shown as “01,02, 15,16,17,18”	A UPS internal fault has occurred.	Contact ZIGOR.
Battery backup time is shorter than nominal value	Batteries are not fully charged	Charge the batteries for at least 6 hours and then check capacity. If the problem still persists, consult ZIGOR.
	Batteries defect	Contact ZIGOR to replace the battery.

Table 6-1 Troubleshooting

Given the complexity of the equipment, when a serious error occurs and causes the equipment to stop, ZIGOR customer service should be contacted to assist you step-by-step to obtain a solution by providing the information requested.

For more information, contact: [www.zigor.com](http://www.zigor.com)  
[sac@zigor.com](mailto:sac@zigor.com)

## 7 MAINTENANCE

You can ask for an offer to ZIGOR in order to perform a basic maintenance of this equipment, so that it can prolong the life of the system.

### 7.1 Maintaining the electronic system

In order to guarantee the correct operation of the ZGR TOWER PRO 1 – 3 KVA, it is necessary to carry out a number of maintenance tasks. These tasks enable resolving defects before breakdowns occur and to ensure correct operation of active and passive safety devices.

The frequency of maintenance tasks is dependent upon the location and the atmospheric conditions. The air quality (temperature, dust in suspension, etc.) has a great influence on the amount of maintenance work to be done in order to maintain the functionalities of the equipment within an acceptable level of uncertainty. That is, for example, if the air contains a great amount of dust in suspension, the maintenance work must be carried out more frequently than the standard frequency indicated.

The recommended maintenance tasks in accordance with frequency are as follows:

- Monthly:
  - Visual control of correct operation.
    - Display and LED indicators indicating correct operation.
    - Values within margins.
    - No active event.
  - Control of the event history, in search of sporadic or repetitive failures.
- 6 monthly:
  - Check on the correct ventilation of the location.
  - Cleaning of the equipment's air inlet filters (if available).
  - Removal of foreign bodies both in the air inlet and outlet.
  - Visual verification of the status of connecting wires, rusting, damage to insulation, etc.
- Annually:
  - Cleaning and blowing of electronic circuits.
  - Checking tightness and status of power and signal wires.
  - Checking of colour changes or by buckling due to hot points.
  - Control of cleaning and water filtrations in the room in which the system is located.
  - Checking the operation of switches and contactors (if available).
  - Checking power and signal fuses.
  - Checking auxiliary voltage sources (if available).



*Incorrect maintenance can render the warranty null and void.*

The rest of the installation must also be maintained adequately. The maintenance tasks to be carried out shall depend on the different elements that make up the installation, emergency generator and cabling. The battery requires special attention.

## 7.2 Battery maintenance



*Efficient maintenance lengthens the service life of batteries and ensures that the unit operates correctly.*

Placing the batteries correctly so that all their elements can be easily reached facilitates maintenance. Maintenance consists of checking the following aspects:

- Cleanliness: The elements, their connections and supports must be kept clean and dry. It is recommended to protect the terminals and metal connections with diluted vaseline. Do not use cleaning products containing solvents and/or harmful substances for cleaning elements with plastic containers.
- Connections and terminals: Check the tightness of nuts on the poles of elements as well as the tightness of the electrical connection with at regular intervals of approximately 12 months.
- Checking voltages: Check the voltages of elements in order to detect any possible anomalies in these.



**WARNING**

*Electrolyte is highly corrosive. In the case of any contact with the skin, remove stained clothing and wash with abundant water those parts of the skin affected. The case of any problem, see a doctor. The case of any contact with one's eyes, rinse with a great deal of water for 10 to 15 minutes and see an ophthalmologist.*

- Periodic Discharges: If, due to use, the batteries do not support systematic charging and discharging operations, the following indications must be applied. In order to maintain the properties of the active material that makes up the battery, the battery must be discharged periodically (it is recommended that this be done every six months). Periodic discharges provide an indication of autonomous operation, allow you to detect faulty elements and discover symptoms of premature ageing. It is not necessary to discharge the battery completely as this might involve a risk of disconnecting the output as the battery does not have its complete capacity. After these intentional discharges, leave the system on for at least 24 hours in order to recharge the battery completely.

Do not smoke, light a fire or generate sparks near batteries during recharging as there is a risk of fire and/or explosion.

For cleaning, do not use synthetic material clothes or sponges. Keep batteries clean and dry at all times. Protect them against dirt, dust, metal shavings, etc.



**WARNING**

*If the ZGR TOWER PRO 1 – 3 KVA is to remain disconnected or shut down during a period of one month or more, the battery switch or protection fuse must be disconnected (if available). The equipment must be kept in a place that is cool and dry.*

### 7.2.1 Battery replacement

Batteries must be placed or handled with special care in accordance with a number of basic accident prevention regulations:

- Do not attempt to open the batteries. These contain electrolyte, which can cause burns to eyes and skin.
- Do not wear rings, bracelets, watches, etc., as these could cause short-circuits or electric shocks.
- Use insulated tools.
- Wear gloves, insulated protective shoe wear and safety goggles.
- Discharge body static electricity before handling connections.
- Do not place tools on the batteries.
- Do not place batteries near fire or sources of heat.
- Do not smoke, there is a risk of explosion.
- Make sure that the equipment is completely switched off and disconnected from the generation and consumption lines before replacing the batteries.



#### *WARNING*

*Batteries are considered to be dangerous waste materials.*

*In order to safeguard the environment, manage used batteries in accordance with the regulations and environmental requirements in force in each country or community.*

Important: Temperature affects the service life of the battery. The optimum temperature is between 20°C and 30°C. An increase of 10°C can reduce its service life by 50%.

## 8 TECHNICAL SPECIFICATIONS

Model ZGR TOWER PRO		1 kVA	1 kVA LBT	2 kVA	2 kVA LBT	3 kVA	3 kVA LBT
<b>INPUT</b>							
Phase		Phase + neutral + ground					
Nominal voltage		200 / 208 / 220 / 230 / 240 Vac					
Admissible voltage range	Low voltage transfer	160 Vac $\pm$ 5 % @ 100~80 % load 140 Vac $\pm$ 5 % @ 80~70 % load 120 Vac $\pm$ 5 % @ 70~60 % load 110 Vac $\pm$ 5 % @ 60~0 % load (Ambient temperature < 35 °C)					
	Low voltage comeback	175 Vac $\pm$ 5 % @ 100~80 % load 155 Vac $\pm$ 5 % @ 80~70 % load 135 Vac $\pm$ 5 % @ 70~60 % load 125 Vac $\pm$ 5 % @ 60~0 % load (Ambient temperature < 35 °C)					
	High voltage transfer	300 Vac $\pm$ 5 %					
	High voltage comeback	290 Vac $\pm$ 5 %					
Admissible frequency range		40 ~ 70 Hz					
Power factor		0,99 (@ 100 % load)					
Bypass voltage range		176 - 264 Vac (configurable)					
Generator input		Support					
<b>OUTPUT</b>							
Power		1000 VA / 900 W		2000 VA / 1800 W		3000 VA / 2700 W	
Power factor		0,9					
Phase		Phase + neutral + ground					
Output voltage		200 / 208 / 220 / 230 / 240 Vac					
Voltage regulation		$\pm$ 1 %					
Frequency		50 / 60 $\pm$ 3 Hz (normal mode) $\pm$ 0,1 Hz (battery mode)					
Crest factor		3:1					
Harmonic distortion (THDv)		$\leq$ 3 % (linear load) $\leq$ 6 % (non-linear load)					
Waveform		Pure Sinewave					
Transfer time		0 ms					
Overload		10 min. @ 105%~110% load, 1 min. @ 110%~130% load, 5 sec. @ 130%~150% load, immediately @ > 150% load (Ambient temperature < 35 °C)					
Connections		2+2 IEC-C13	2+2 IEC-C13	4+4 IEC-C13 +terminals	4+4 IEC-C13 +terminals	4+4 IEC-C13 +terminals	4+4 IEC-C13 +terminals
<b>BATTERY</b>							
Battery type		Sealed Pb					
Battery nominal voltage		24 V	36 V	48 V	72 V	72 V	96 V
No Batteries		2	3	4	6	6	8
Battery capacity		12 V / 9 Ah	Depend on autonomy	12 V / 9 Ah	Depend on autonomy	12 V / 9 Ah	Depend on autonomy
Recharge time at 90%		4h (typical)					
Charge current		1A	12A max. (adjustable)	1A	12A max. (adjustable)	1 A	12 A max. (adjustable)

OTHERS						
UPS topology	Online, Doble-conversion, PFC, PWM Controlled, tower format					
Efficiency	Up to 88%	Up to 90%			Up to 92%	
Cold-start	Yes					
Re-start	Yes					
Communications	Standard: USB and RS232 ports Optional: SNMP/Modbus TCP or dry contact cards					
Battery test function	Yes					
Control panel	LCD display and LED indicators					
Alarms	AC input abnormal, low battery, overload, failure					
Protect function	Battery low voltage, overload, over-temperature, shortcircuit, output over/low voltage					
Protection degree	IP20					
Cooling	Forced ventilation					
Noise level	< 50 dBA (@ 1 m)					
Working temperature	0 ~ 40 °C					
Storage temperature	-25 ~ 55 °C					
Relative humidity	20 ~ 90 % (without condensation)					
Altitude	< 1500 m (without power reduction)					
Dimensions (W × H × D)	145 x 215 x 300 mm	145 x 215 x 300 mm	192 x 335 x 470 mm	192 x 335 x 470 mm	192 x 335 x 470 mm	192 x 335 x 470 mm
Weight	9,2 kg	4,3 kg	19,5 kg	7,8 kg	26,5 kg	8,4 kg
External battery cabinet*						
Dimensions (W × H × D)	NA	145 x 215x 400 mm	NA	192 x 335x 470 mm	NA	192 x 335x 470 mm
Weight w/o batteries		4,2 kg		7,6 kg		7,9 kg

- Other battery cabinet sizes could be used in case of bigger battery and/or autonomy.
- The technical specifications may be modified without prior notice.
- For any other technical need or modification of existing ones, consult ZIGOR.

## 9 STANDARDS

ZGR TOWER PRO 1 – 3 KVA model comply with the following European regulations:

- I. LVD Security directive LVD 2014/35/EU about Uninterruptible Power Supply (UPS)  
Standard: EN 62040-1: 2019
- II. EMC directive 2014/30/EU about electromagnetic compatibility (EMC)  
Standard: EN/IEC 62040-2:2018  
EN/IEC 61000-3-2:2019  
EN 61000-3-3:2013+A1:2019
- III. Conformity:  
UPS Classification: EN/IEC 62040-3:2011



## 10 WARRANTY

Unless otherwise agreed, ZIGOR guarantees that ZGR TOWER PRO 1 – 3 KVA units leave the factory in perfect working order and free of any defects for a period of 24 months to be counted as of the date of sale of the apparatus, shown in the delivery note and/or invoice.

ZIGOR will guarantee to the Buyer, the proper functioning against manufacturing and/or workmanship defects. This Warranty includes, whenever the circumstances of good use on the equipment, replace, repair (workmanship included) or refund the purchase price as paid by the customer within the above specified period according to the type of defect and are only and exclusive remedies guaranteed under this Limited Warranty.

The replacement of spare parts, if required, will be made with other new or repaired parts and the replaced ones will become property of ZIGOR.

**Unless otherwise agreed, it's not included any assistance and / or displacement. If demanded by the buyer, he'll be held responsible for it.**

The customer will be free of charge provided the cause of equipment failure due to defective material thereof, without being affected by the exclusion of warranty causes described in the next section. In any other circumstances be charged the amount of economic displacement.

The following situations will cancel the guarantee of the product:

- Faults due to improper handling of the product, according to the operating instructions, misuse, default grid or by storm.
- Improper use of the equipment according to the Operating Manual and without respecting the original characteristics of the equipment.
- Installation in a place/ environment that does not meet the requirements indicated in the Operating Manual referring to the Installation Conditions.
- When the customer not clearly proves the systematic realization of regular maintenance operations described in the Operating Manual.
- Equipment deterioration due to external agents (water, dirt, animals, etc.)
- Damages caused by accident, theft, fire, inadmissible atmospheric conditions, external agents (animals, insects, etc.) or natural disasters.
- In case of any intervention and/or repair by an unauthorised Technical Service.
- The use of equipment or accessories, not sell and/or installed by ZIGOR or their Authorised Technical Service.
- Environmental Operating Conditions out of range.

When the unit is equipped with lead-acid batteries, it must be considered the following precautions:

Those elements are fully charged before shipment. They can be stored for up 2 years provided that they are charged at minimum intervals of 6 months during their storage.

*The installation of elements inside the unit by personnel other than those authorised by ZIGOR, shall render the warranty null and void. ZIGOR will not accept responsibility for the repair of equipment if any of the seals installed for internal checks is broken.*

*The validity of this guarantee is limited to the proper use of the equipment according to the Operating Manual and while respected the original characteristics of the equipment.*

The Spanish Standardisation and Certification Association (AENOR) certifies that the “Quality Assurance ” and “Environmental Management Systems” adopted by ZIGOR CORPORACIÓN, S.A. for the design, development, production and after sales service for electronic equipment for the conversion of direct and alternating current as well as electronic projections, communications systems, telemanagement applications and electrical and electronic turnkey projects, is an agreement with the requirements of the Spanish Standards UNE-EN ISO 9001 and UNE-EN ISO 14001 respectively.







Zigor Corporación  
Portal de Gamarra 28- 01013  
Vitoria-Gasteiz Álava/Spain  
+34 945 21 46 00  
[www.zigor.com](http://www.zigor.com)

*Consulte nuestra web para contactar con la red de delegaciones comerciales  
Refer to our website in order to contact the commercial branches network*